

Elmasonic Table top units Accessories

Product Information

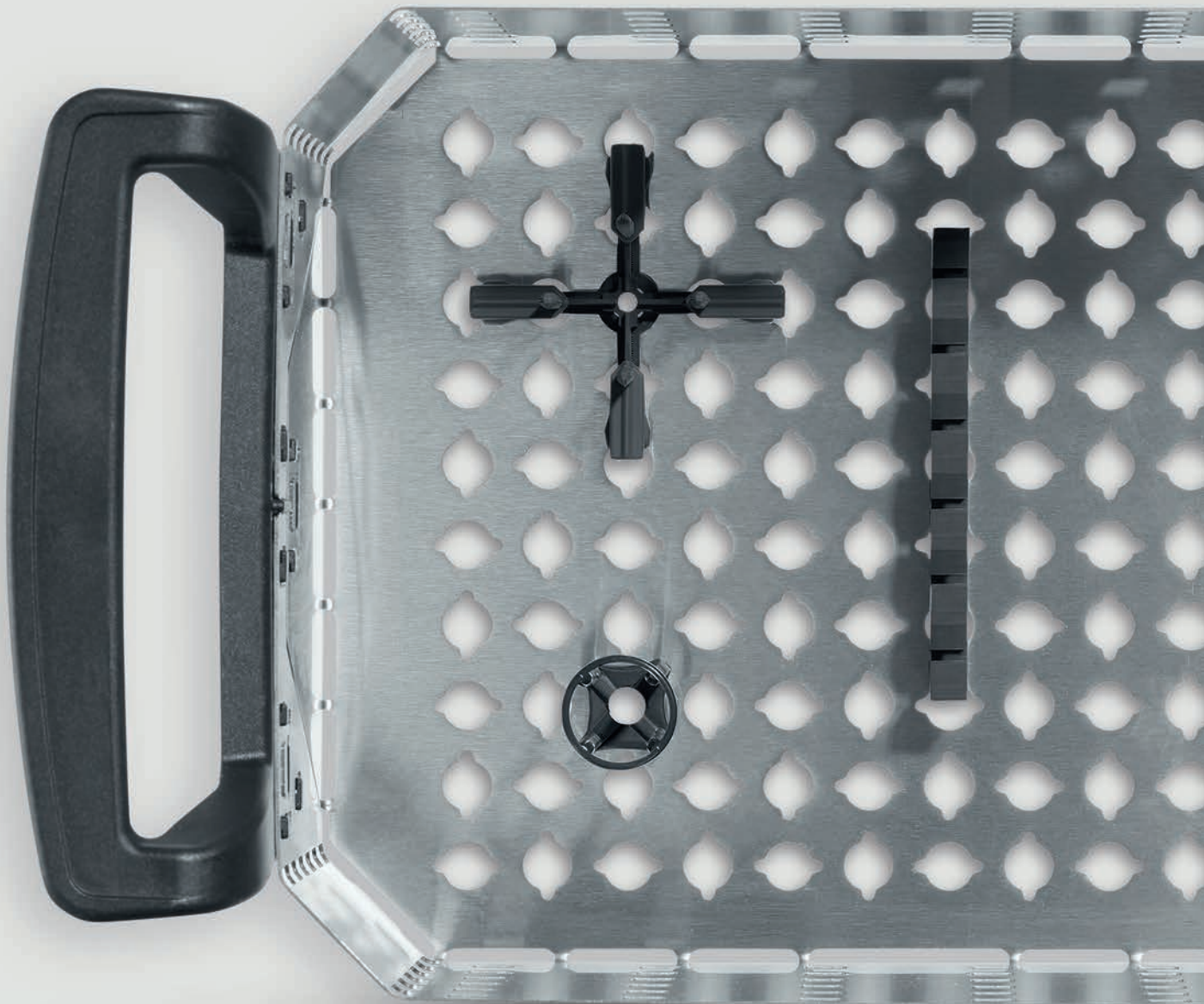

Contents

- Modular basket system	3
Modular basket	3
Level set	5
Dividing wall set.	7
Holder set	9
Silicone holder set.	11
Elma starter Set.	12
Elma Pin Set	13
Silicone holder set (Bottom comb / Side comb)	15
Basket for small parts	17
- Baskets	19
Basket	19
Stacking basket.	21
- Covers	22
Stainless steel lid.	22
Plastic lid	24
Noise protection covers.	26
- Holders and product carriers	27
Equipment holder	27
Test tube holder.	28
Holder for reaction tubes.	30
Hooks holder	32
Ring stand	34
Holding clamps for Erlenmeyer flasks.	35
Dental-Tray holder.	38
- Inserts	40
Acid resistant insert tray	40
BD-Steribox.	42
Cleaning cup	43
Cleaning glasses.	45
Immersion baskets	53
Hostal tub	55
Silicone mats.	57
Small parts holder	59
- Practicals	60
Cooling coil	60
Drain sieve	61
Sieve cleaning module SRH 4 / 200	62
- Elma Mutebox.	64
- Elma Sink	67
- Elma Dry	70

Product Information



Elmasonic Accessories - Modular basket system

Modular basket

- stainless steel with plastic handles (10 - 120 & 180 - 300) or Rilsan coating (150)
- ergonomic handles
- autoclavable
- Bayonet holes in the bottom for mounting holders (e.g. Elma Pin, silicone holder bottom comb)
- Square openings in the side walls for mounting silicone holders

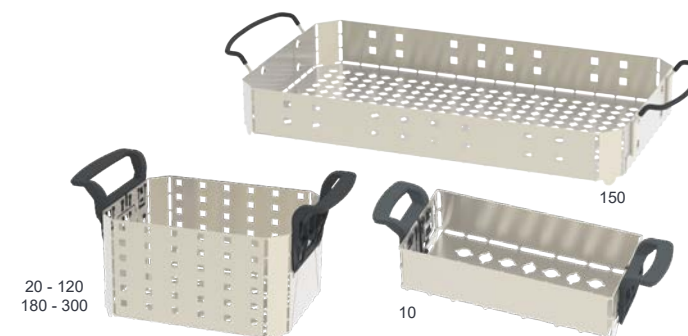

Basket size	10	20	30	40	60	80	100	120	150	180	300	
Order number	1117923	1119922	1108916	1113045	1113050	1111838	1113387	1113390	1113110	1113404	1113072	
Int. dim. of basket W / D / H (mm)	155 / 70 / 35	110 / 105 / 50	195 / 105 / 50	195 / 105 / 95	255 / 105 / 95	455 / 105 / 55	250 / 195 / 90	250 / 195 / 135	450 / 255 / 55	280 / 255 / 135	450 / 255 / 135	
Chamfer V x W (mm)	--	20 x 20					25 x 25					
Hole diameter bottom Y x Z (mm)	11 x 15											
Hole diameter sides Y ₁ x Z ₁ (mm)	--	10 x 10										
Loading weight max. (kg)	1,0	1,0	1,0	3,0	5,0	5,0	6,0	7,0	7,0	8,0	10,0	
Suitable for unit / bath size	10	15	20	30	40	60	80	100	120	150	180	300
• Elmasonic Easy	•		•	•	•	•		•	•		•	•
• Elmasonic Med				•	•	•		•	•		•	•
• Elmasonic Select				•	•	•		•	•		•	•
• Elmasonic S	•	•		•	•	•		•	•		•	•
• Elmasonic P				•	•	•	•	•	•		•	•
• Elmadry				•				•				•
• Elma Sink					•	•					•	•

All prices ex works, excluding packaging.

Technical specifications serve as orientation values and are subject to tolerances due to production and manufacturing. Proper operation can only be guaranteed when using original Elma devices.

2023_05_20_Subject to technical and visual modifications.

Elmasonic Accessories - Modular basket system

Modular basket

Dimension definition

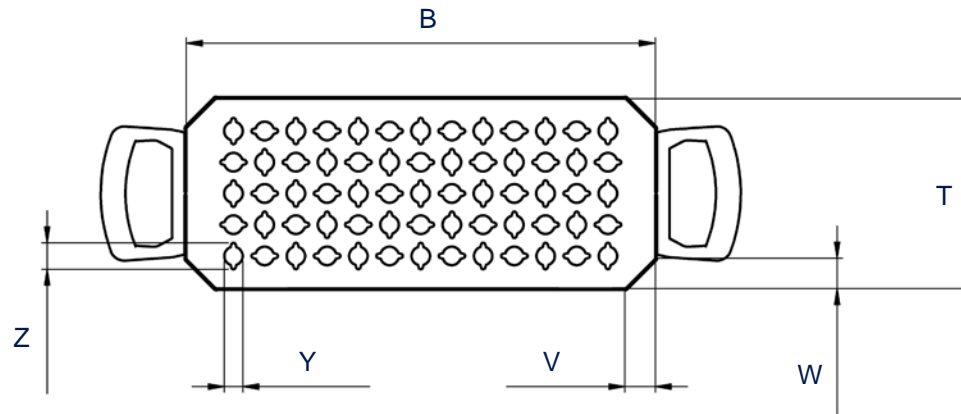
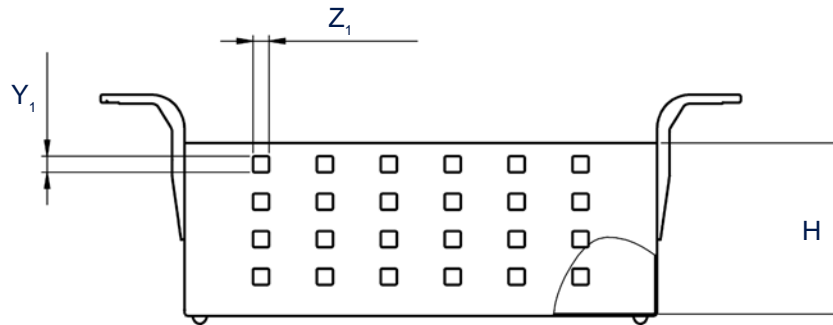

The drawings are meant as a visualization aid and are not true to scale.

Technical specifications serve as orientation values and are subject to tolerances due to production and manufacturing. Proper operation can only be guaranteed when using original Elma devices.

Elmasonic Accessories - Modular basket system

Level set

- Level made of stainless steel
- for horizontal division of the modular basket
- Product contents Level set:
 - Level size S and M: 1x Level + 5x Silicone holder per set
 - Level size L and XL: 1x Level + 10x Silicone holder per set
- maximum one horizontal division per modular basket allowed
- the level can be used at different heights
- autoclavable
- Bayonet holes in the bottom for mounting holders (e.g. Elma Pin, silicone holder bottom comb)



Level size	S	M	L	XL
Order number	1125225	1125226	1125227	1125228
Ext. dimension W / D / H (mm)	195 / 105 / 1	255 / 105 / 1	250 / 195 / 1	285 / 250 / 1
Hole diameter Dia (mm)	11 x 15			
Weight per level (g)	110	150	280	410
Max. loading weight per basket size and level (kg)	1,0	1,0	2,0	2,0

Level size	S	M	L	XL
Suitable for basket size:				
30	1 set			
40	1 set			
60		1 set		
80	2 sets side by side			
100			1 set	
120			1 set	
150			2 sets side by side	
180				1 set
300			2 sets side by side	

All prices ex works, excluding packaging.

Technical specifications serve as orientation values and are subject to tolerances due to production and manufacturing. Proper operation can only be guaranteed when using original Elma devices.

Elmasonic Accessories - Modular basket system

Level set

Dimension definition

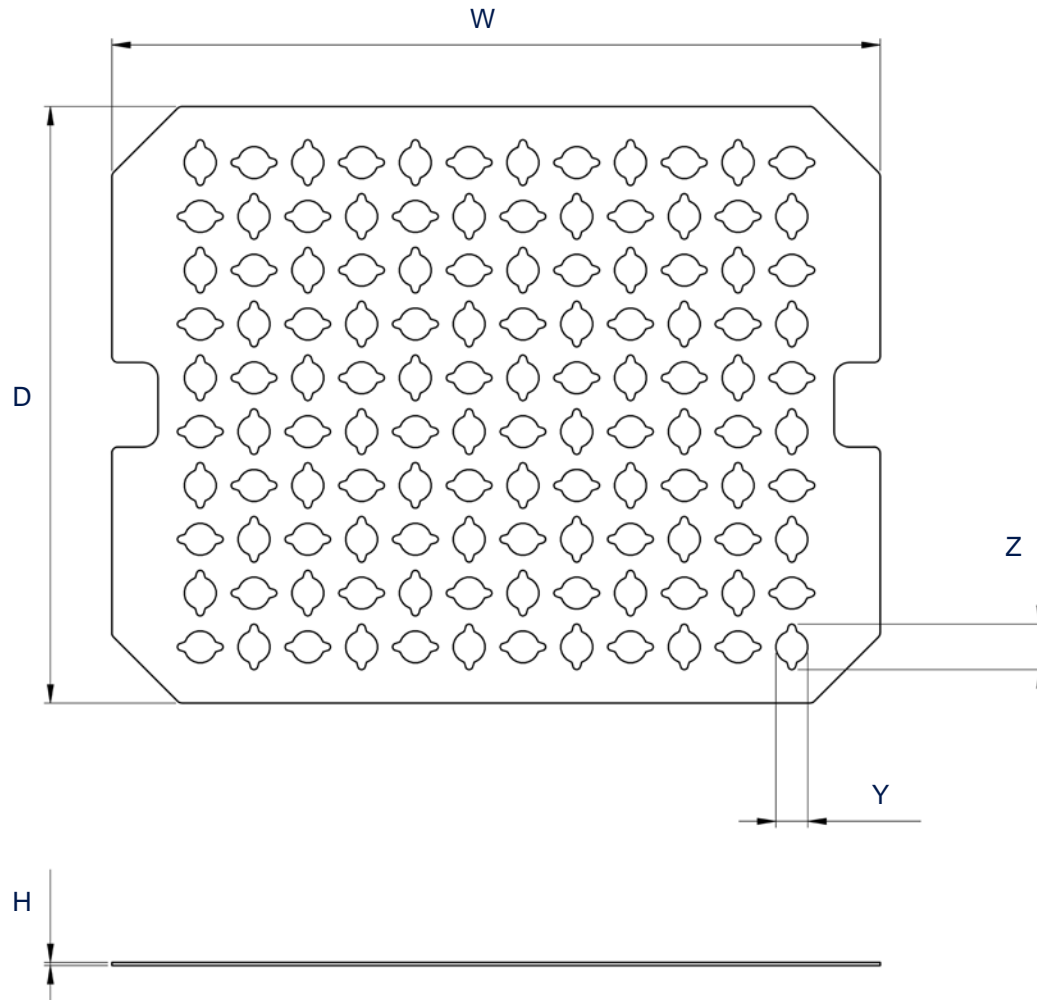

Example of application

Basket size 60 with Level set size M

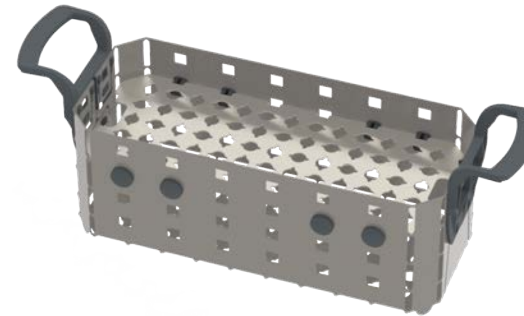

Basket size 300 with 2 Level sets size L side by side

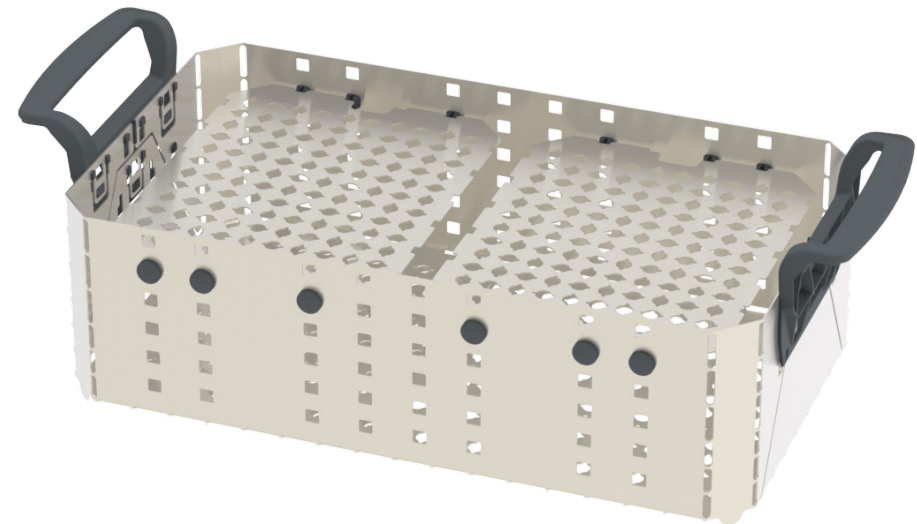

The drawings are meant as a visualization aid and are not true to scale.

Technical specifications serve as orientation values and are subject to tolerances due to production and manufacturing. Proper operation can only be guaranteed when using original Elma devices.

Elmasonic Accessories - Modular basket system

Dividing wall set

- Dividing wall made of stainless steel
- for vertical division of the modular basket
- Product contents Dividing wall set: 2x Dividing wall + 10x Silicone holder per set
- autoclavable
- Square openings in the side walls for mounting silicone holders

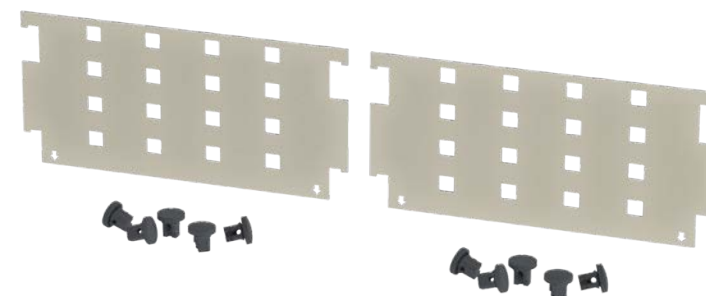

Dividing wall size	S low	S high	M	L low	L high
Order number	1125220	1125221	1125223	1125222	1125224
Ext. dimension W / D / H (mm)	105 / 50 / 1	105 / 90 / 1	200 / 60 / 1	200 / 90 / 1	255 / 130 / 1
Hole diameter Dia (mm)	10 x 10				
Weight per dividing wall (g)	70	40	130	100	230

Dividing wall size	S low	S high	M	L low	L high
Suitable for basket size:					
20	1 Set				
30	2 Sets				
40	2 Sets	2 Sets			
60	2 Sets	2 Sets			
80	4 Sets	4 Sets			
100	2 Sets	2 Sets	2 Sets		
120	2 Sets	2 Sets	2 Sets		
150	4 Sets			4 Sets	
180	2 Sets	2 Sets			2 Sets
300	4 Sets	4 Sets			2 Sets

All prices ex works, excluding packaging.

Technical specifications serve as orientation values and are subject to tolerances due to production and manufacturing. Proper operation can only be guaranteed when using original Elma devices.

Elmasonic Accessories - Modular basket system

Dividing wall set

Dimension definition

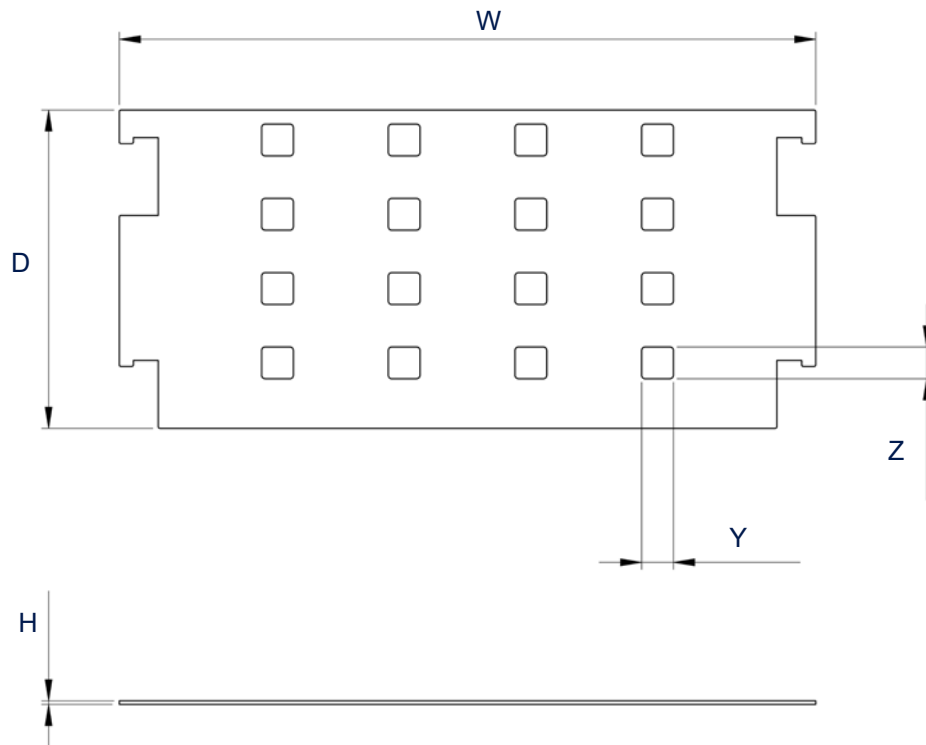

Example of application

Basket size 300 with 2x Dividing wall set L high + 1x Dividing wall set S high

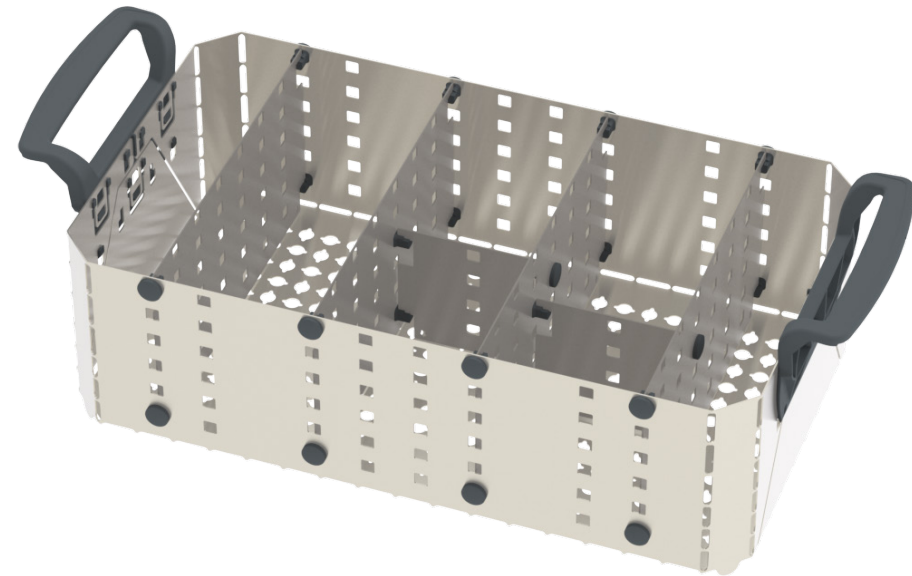

Basket size 30 with 2x Dividing wall set S low

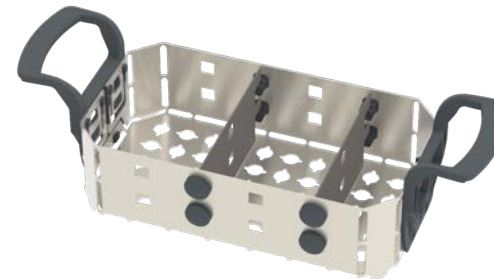

The drawings are meant as a visualization aid and are not true to scale.

Technical specifications serve as orientation values and are subject to tolerances due to production and manufacturing. Proper operation can only be guaranteed when using original Elma devices.

Elmasonic Accessories - Modular basket system

Holder set

- made of stainless steel
- Holder hooks Rilsan-coated
- Holder hooks with 10 hooks
- Holder hooks for holding e.g. jewelry and watch parts
- Holder shaft with 4 shaft
- Holder shaft for holding e.g. Impression tray
- Product contents Holder set: 1x Holder shaft, 1x Holder hooks, 5x Silicone holder per set



dimension definition

Holder shaft

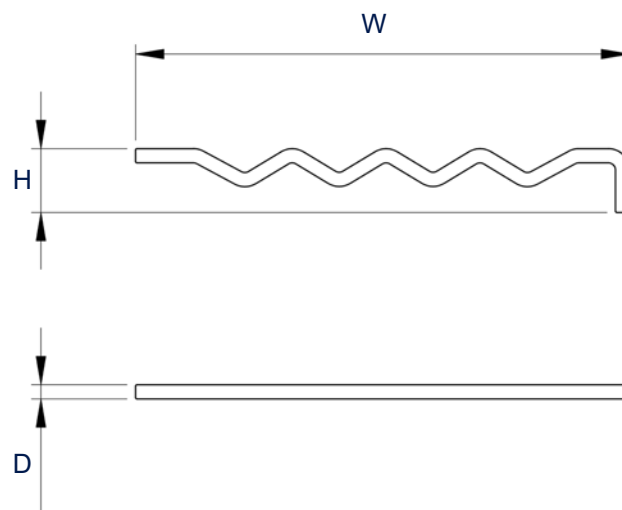

Holder hooks

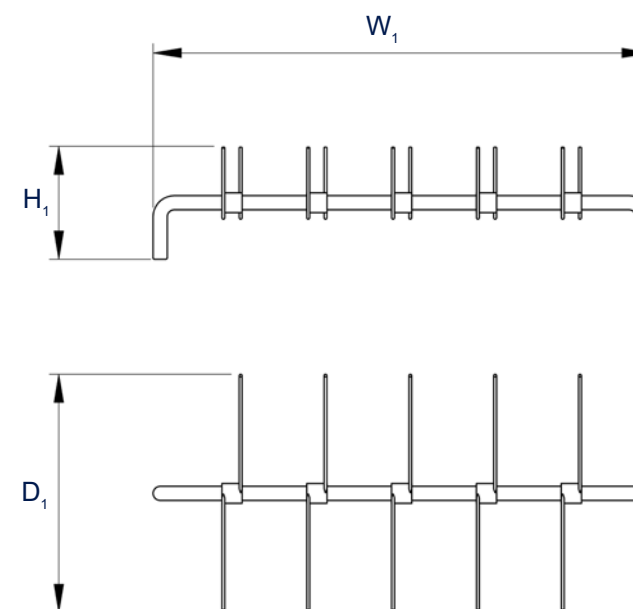

	Holder set
Order number	1125219
Ext. dimension Holder shaft $W / W / H$ (mm)	105 / 3 / 15
Ext. dimension Holder hooks $W_1 / D_1 / H_1$ (mm)	110 / 55 / 25
Weight bracket shaft (g)	7
Weight holder hooks (g)	9

All prices ex works, excluding packaging.

The drawings are meant as a visualization aid and are not true to scale.

Technical specifications serve as orientation values and are subject to tolerances due to production and manufacturing. Proper operation can only be guaranteed when using original Elma Units.

Elmasonic Accessories - Modular basket system

Holder set

Example of application

Basket size 60 with 1x Holder set

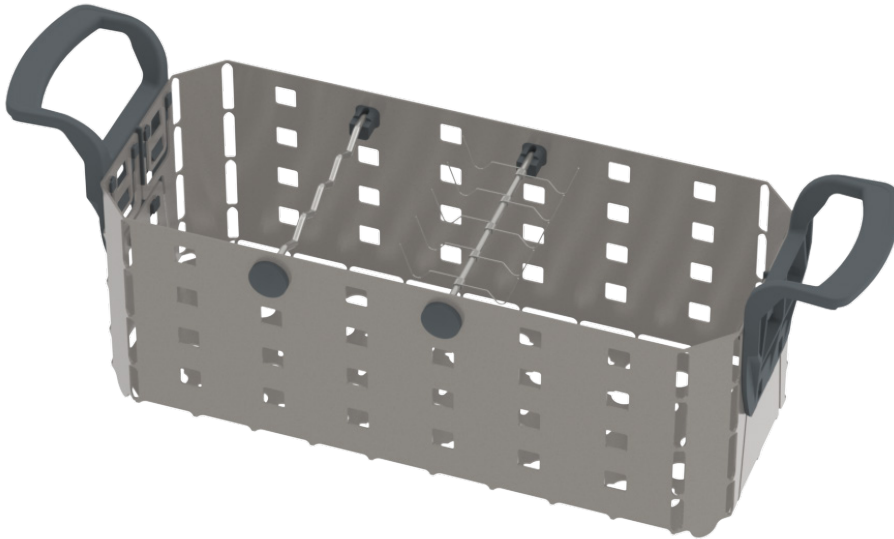

The drawings are meant as a visualization aid and are not true to scale.

Technical specifications serve as orientation values and are subject to tolerances due to production and manufacturing. Proper operation can only be guaranteed when using original Elma devices.

Elmasonic Accessories - Modular basket system

Silicone holder set

- for mounting levels, dividing walls and supports
- Product contents Silicone holder set: 10x Silicone holder per set
- easy handling
- easy positioning



dimension definition

	Silicone holder set
Order number	1125208
Ext. dimension Dia / H (mm)	20 / 20
Weight per silicone holder (g)	4

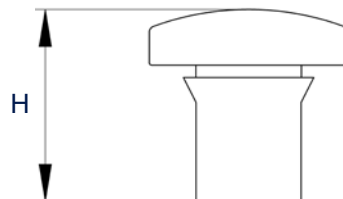
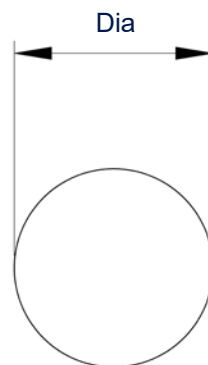

All prices ex works, excluding packaging.

The drawings are meant as a visualization aid and are not true to scale.

Technical specifications serve as orientation values and are subject to tolerances due to production and manufacturing. Proper operation can only be guaranteed when using original Elma Units.

Elmasonic Accessories - Modular basket system

Elma starter Set

- Product contents Elma starter Set: 3x each Elma Pin 0741 and 0772 per set
2x each Elma Pin 0509, 0158, 0767, 0613+0614, 0021R and 0001R per set
2x silicone holder side comb and bottom comb each per set
- for further features on the individual Elma pins and silicone holders, see page 9 onwards

	Elma starter Set
Order number	1124042

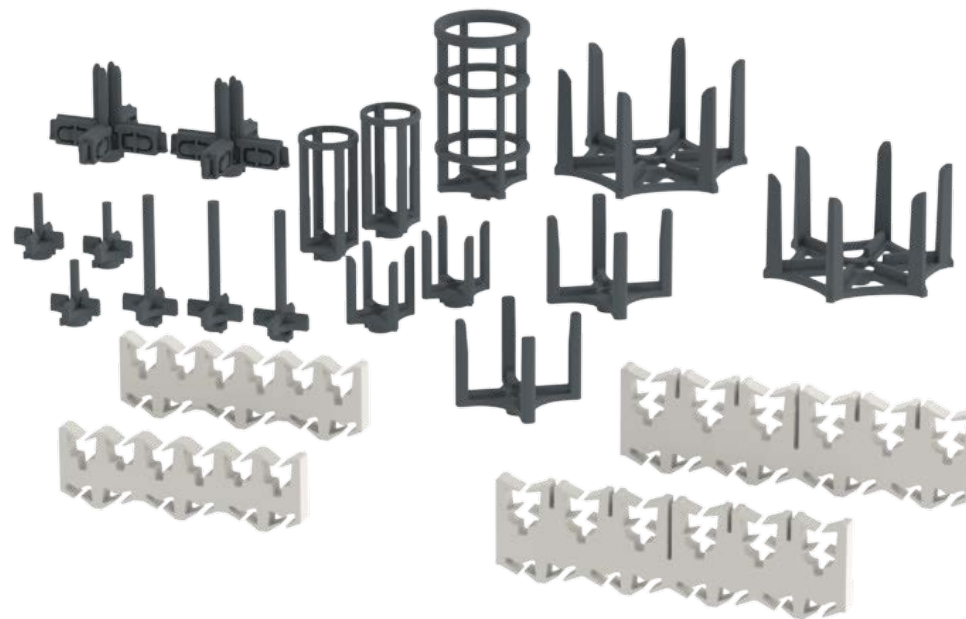

All prices ex works, excluding packaging.

The drawings are meant as a visualization aid and are not true to scale.

Technical specifications serve as orientation values and are subject to tolerances due to production and manufacturing. Proper operation can only be guaranteed when using original Elma Units.

Elmasonic Accessories - Modular basket system

Elma Pin Set

- made of plastic
- Color: Black
- For mounting and holding various components
- Product contents Elma Pin Set: 10x Elma Pin per set
- Bayonet lock for easy mounting on the bottom of the baskets and on the levels



Elma Pin	0509	0158	0767	0613 + 0614		0741	0772	0021R	0001R
Order number	1125209	1125210	1125211	1125212		1125214	1125213	1125216	1125215
Ext. dimension Dia / H (mm)	30 / 35	50 / 40	85 / 65	55 / 45	75 / 45	25 / 30	25 / 55	25 / 55	40 / 75
int. dimension Dia ₁ / H ₁ (mm)	20 / 20	40 / 25	50 / 35	0,35 / 25	25 / 25	4 / 15	5 / 40	15 / 40	30 / 65
Outer overlay Dia ₂ (mm)	--	--	--	15	40	--	--	--	--
Weight per Elma Pin (g)	3	6	7	6		2	3	4	8
									

All prices ex works, excluding packaging.

Technical specifications serve as orientation values and are subject to tolerances due to production and manufacturing. Proper operation can only be guaranteed when using original Elma devices.

Elmasonic Accessories - Modular basket system

Elma Pin Set

Dimension definition

Elma Pin 0509 & 0158

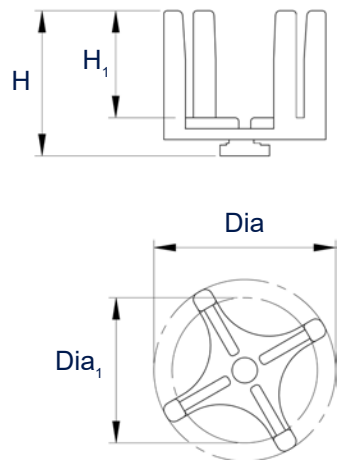

Elma Pin 0767

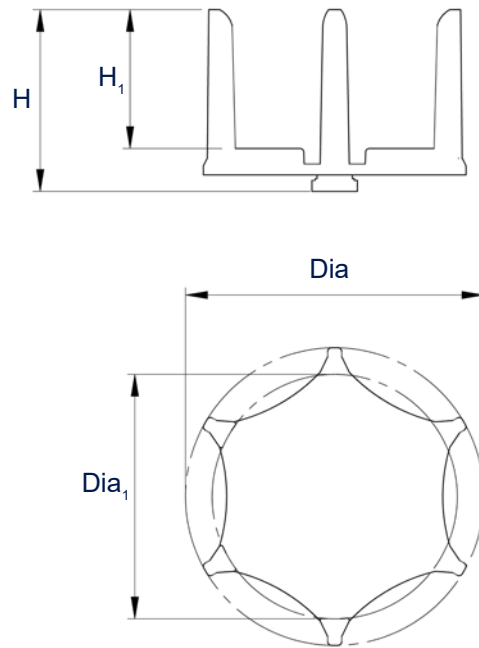

Elma Pin 0613 & 0614

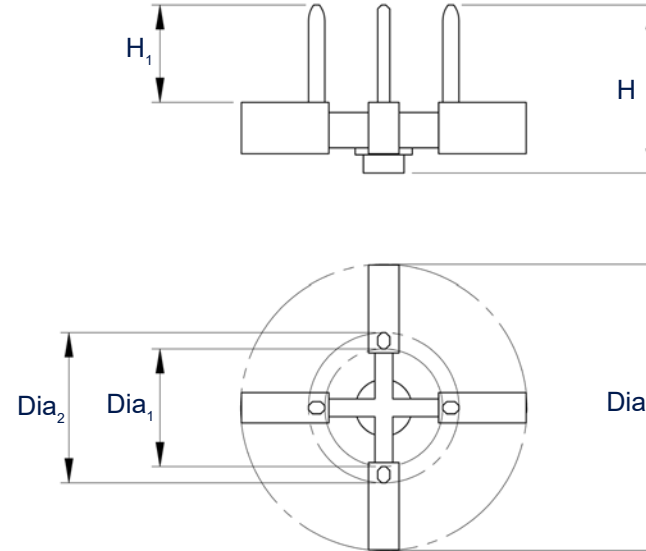

Elma Pin 0741 & 0772

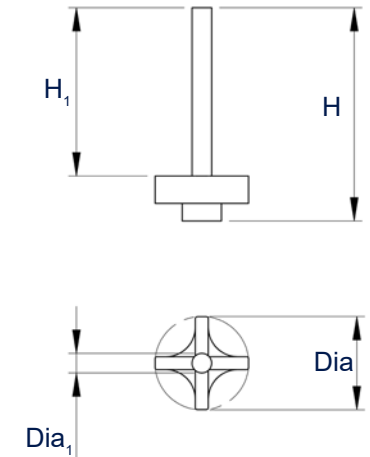

Elma Pin 0021R & 0001R

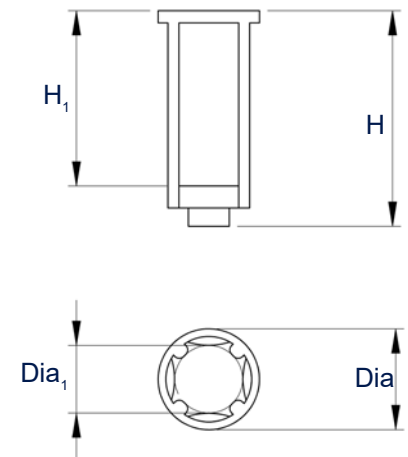

The drawings are meant as a visualization aid and are not true to scale.

Technical specifications serve as orientation values and are subject to tolerances due to production and manufacturing. Proper operation can only be guaranteed when using original Elma Units.

Elmasonic Accessories - Modular basket system

Silicone holder set (Bottom comb / Side comb)

- for holding various instruments, containers (e.g. flasks) and workpieces
- Scope of delivery silicone holder set bottom comb: 10x silicone holder bottom comb each per set
- Scope of delivery silicone holder set side comb: 5x silicone holder side comb each per set
- Color: White

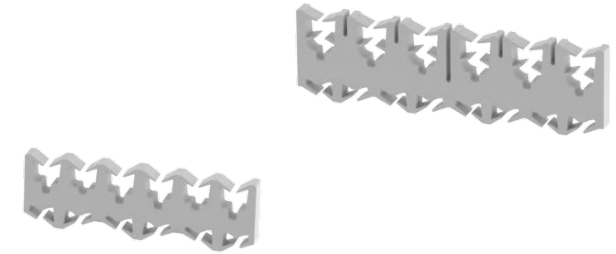

dimension definition

	Bottom comb	Side comb
Order number	1125217	1125218
Ext. dimension W / D / H (mm)	105 / 10 / 35	150 / 10 / 45
Weight per silicone holder (g)	35	71

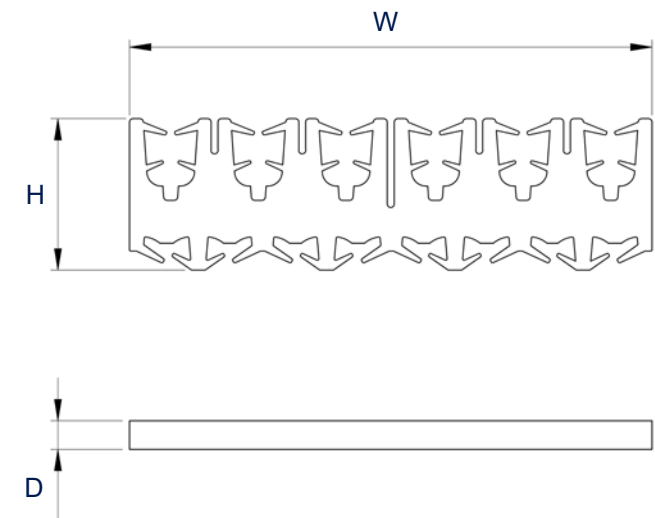
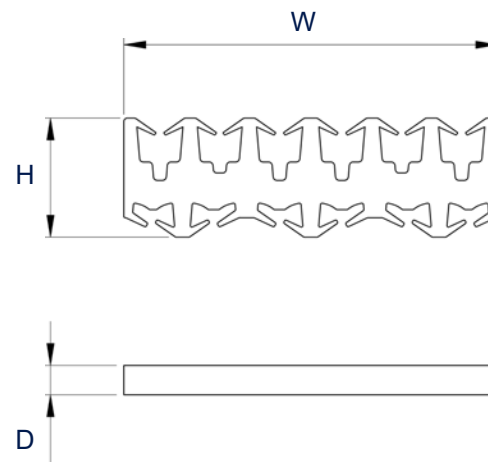

All prices ex works, excluding packaging.

The drawings are meant as a visualization aid and are not true to scale.

Technical specifications serve as orientation values and are subject to tolerances due to production and manufacturing. Proper operation can only be guaranteed when using original Elma Units.

Elmasonic Accessories - Modular basket system

Silicone holder set (Bottom comb / Side comb)

Example of application

Basket size 150 with 2x Bottom comb

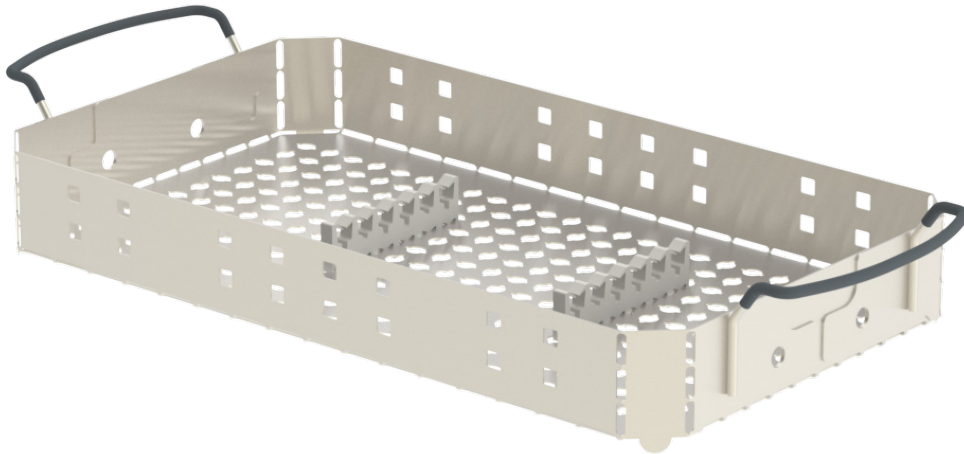

Basket size 60 with 1x Side comb

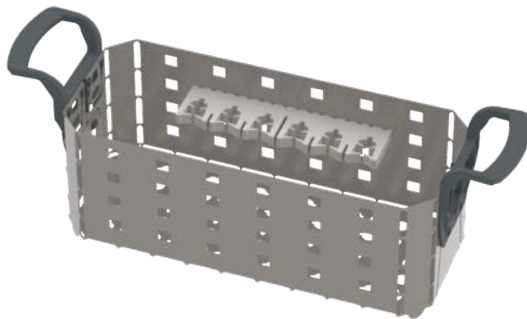

The drawings are meant as a visualization aid and are not true to scale.









Technical specifications serve as orientation values and are subject to tolerances due to production and manufacturing. Proper operation can only be guaranteed when using original Elma Units.

Elmasonic Accessories - Modular basket system

Basket for small parts

- Basket for cleaning small parts
- made of stainless steel
- compatible with Elma pins

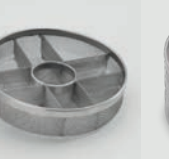

	Basket 1-piece 1 / 3 height	Basket 5-pieces 1 / 3 height	Miniature basket	Cover for Miniature basket	Cover for basket	Basket 4-pieces 1 / 3 height	Basket 9-pieces 1 / 3 height	Basket 1-piece 1 / 1 height
Order number	3000006012	3000006014	3000006017	3000006016	3000006018	3000006013	3000006015	3000009104
Ext. dimensions Dia / H (mm)	64 / 16	64 / 16	21 / 12	20 / 4	64 / 2	64 / 16	64 / 16	64 / 42
Int. dimensions Dia ₁ / H ₁ (mm)	60 / 15	60 / 15	18 / 11	--	--	60 / 15	60 / 15	60 / 41
								

All prices ex works, excluding packaging.

The drawings are meant as a visualization aid and are not true to scale.

Technical specifications serve as orientation values and are subject to tolerances due to production and manufacturing. Proper operation can only be guaranteed when using original Elma devices.

Elmasonic Accessories - Modular basket system

Basket for small parts

Dimension definition

Baskets

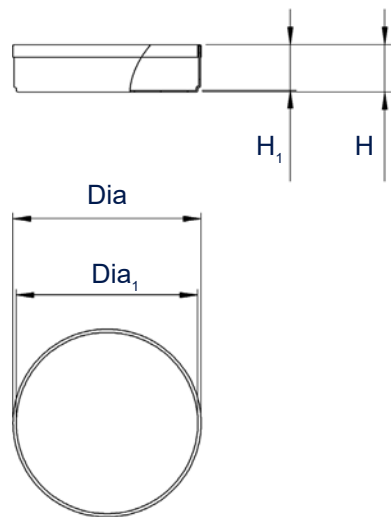

Covers

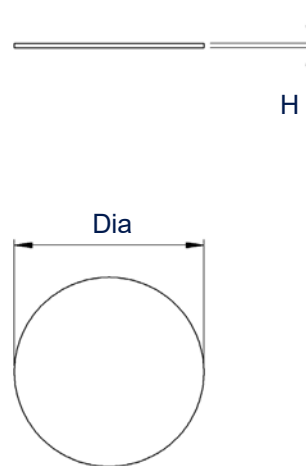

The drawings are meant as a visualization aid and are not true to scale.

Technical specifications serve as orientation values and are subject to tolerances due to production and manufacturing. Proper operation can only be guaranteed when using original Elma devices.

Product Information



Elmasonic Accessories - Baskets

Basket

- made of stainless steel and with Rilsan-coated handles
- the basket 200 (order no. 1108458) also serves as a holder for sterilisation baskets
 - DIN 1 / 1 short (W / D - 485 / 253 mm) (H - max. 100 mm)
 - DIN 3 / 4 (W / D - 406 / 253 mm) (H - max. 100 mm)



	70	100 medium	120 medium	100 flat	120 flat	200	500	900
Order number	1004247	1071801		1077166		1108458	1107675	1107641
Basket int. dim. W / D / H (mm)	465 / 105 / 50	255 / 200 / 45		255 / 200 / 25		490 / 255 / 95	460 / 300 / 195	545 / 460 / 190
Mesh size Y x Z (mm) / Hole diameter Dia (mm)	9 x 1					11	11	
Loading weight max. (kg)	5,0	6,0				4,0	20,0	30,0
Suitable for	70	100	120	100	120	200	500	900
• Elmasonic Easy		•	•	•	•			
• Elmasonic Med		•	•	•	•	•	•	•
• Elmasonic Select		•	•	•	•		•	•
• Elmasonic S		•	•	•	•		•	•
• Elmasonic P	•		•		•			
• Elmadry TD			•		•			

All prices ex works, excluding packaging.

Technical specifications serve as orientation values and are subject to tolerances due to production and manufacturing. Proper operation can only be guaranteed when using original Elma devices.

Elmasonic Accessories - Baskets

Basket

Dimension definition

Basket internal dimensions

Hole diameter

Dia = Hole diameter (basket sizes 200, 500, 900)

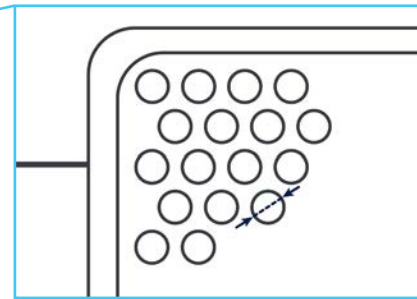

Mesh size

Y = Mesh size; Z = Wire diameter (basket sizes 70, 100 medium / flat, 120 medium / flat)

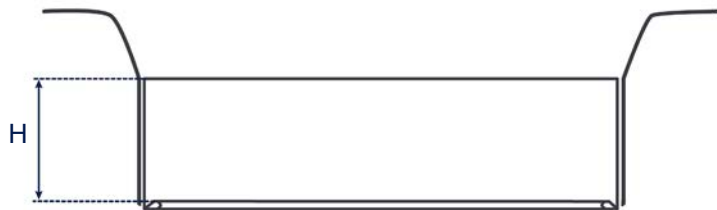
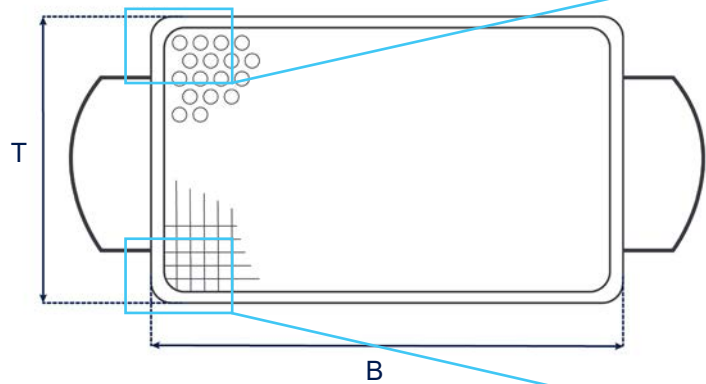
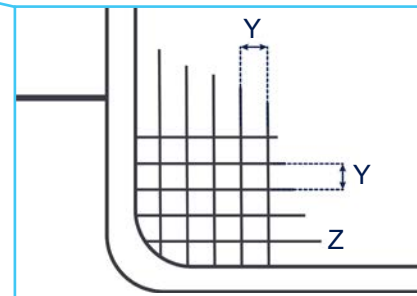

The drawings are meant as a visualization aid and are not true to scale.

Technical specifications serve as orientation values and are subject to tolerances due to production and manufacturing. Proper operation can only be guaranteed when using original Elma devices.

Elmasonic Accessories - Baskets

Stacking basket

- made of stainless steel and with Rilsan-coated handles



	180
Order number	2070880000
Basket int. dim. lower basket W / D / H (mm)	270 / 240 / 50
Basket int. dim. upper basket W / D / H (mm)	265 / 235 / 50
Mesh size Y x Z (mm)	9 x 1
Loading weight max. (kg)	8,0

All prices ex works, excluding packaging.

Technical specifications serve as orientation values and are subject to tolerances due to production and manufacturing. Proper operation can only be guaranteed when using original Elma devices.

Elmasonic Accessories - Covers

Stainless steel lid

- reduce the noise of the ultrasonic cleaning
- save energy and costs by reducing waste heat and collecting / recirculating the water vapour



	30	40	60	100	120	150	180	300	500	900
Order number	1111930		1111931	1111932		1111933	1111934	1111933	1082096	1082091
External dimensions W / D / H (mm)	265 / 160 / 55		325 / 175 / 55	325 / 265 / 55		530 / 325 / 55	355 / 325 / 55	530 / 325 / 55	540 / 370 / 50	650 / 550 / 50
Suitable for	30	40	60	100	120	150	180	300	500	900
• Elmasonic Easy	•	•	•	•	•		•	•		
• Elmasonic Med	•		•	•	•		•	•	•	•
• Elmasonic Select	•	•	•	•	•	•	•	•	•	•
• Elmasonic S	•	•	•	•	•	•	•	•	•	•
• Elmasonic P	•		•	•	•		•	•		

All prices ex works, excluding packaging.

Technical specifications serve as orientation values and are subject to tolerances due to production and manufacturing. Proper operation can only be guaranteed when using original Elma accessories.

Elmasonic Accessories - Covers

Stainless steel lid

Dimension definition

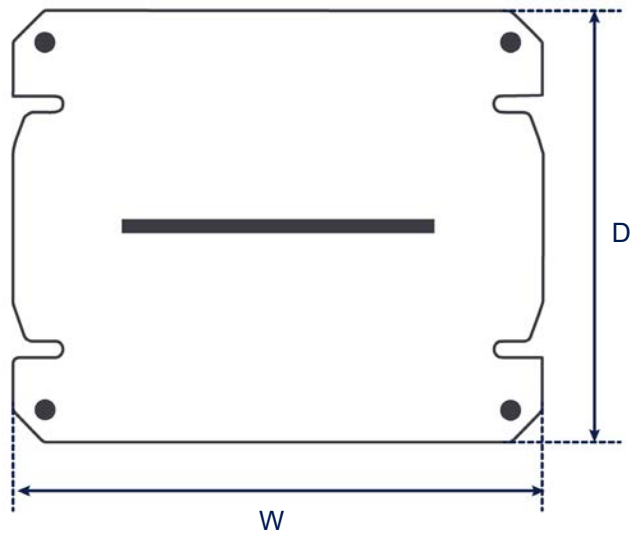
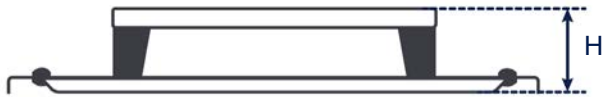

The drawings are meant as a visualization aid and are not true to scale.

Technical specifications serve as orientation values and are subject to tolerances due to production and manufacturing. Proper operation can only be guaranteed when using original Elma devices.

Elmasonic Accessories - Covers

Plastic lid

- available in cobalt blue (RAL 5013)*¹, ultramarine blue (RAL 5002)*² and silver grey (RAL 7001)*³
- reduce the noise of the ultrasonic cleaning
- save energy and costs by collecting and recirculating evaporating water from the ultrasonic bath
- serve upside down as a drip tray for the basket and cleaned parts

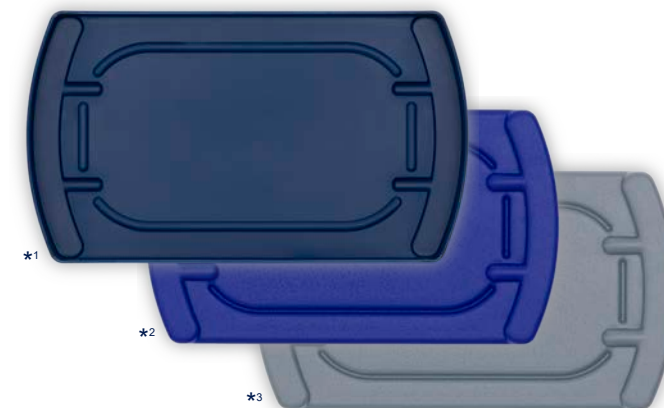

	10	15	20	30	40	60	70	80	100	120	150	300	180	200	
Order number cobalt blue (RAL 5013)* ¹				1101126		1101129		1110200		1101133		1101135		1101141	1106428
Order number ultramarine blue (RAL 5002)* ²	1003278	1003280		1003281		1003282		1003283		1003285		1003287		1003286	--
Order number silver grey (RAL 7001)* ³	1071693	1071694		1071695		1071696		1110202		1071697		1071699		1071698	--
Ext. dimensions W / D / H (mm)	235 / 115 / 20	220 / 175 / 20		305 / 175 / 20		270 / 190 / 20		570 / 170 / 20		380 / 280 / 20		575 / 335 / 20		405 / 340 / 20	600 / 365 / 20
Suitable for	10	15	20	30	40	60	70	80	100	120	150	300	180	200	
• Elmasonic Easy	•		•	•		•			•	•		•	•		
• Elmasonic Med				•		•			•	•		•	•		•
• Elmasonic Select				•	•	•		•	•	•	•	•	•	•	
• Elmasonic S	•	•		•	•	•		•	•	•	•	•	•	•	
• Elmasonic P				•		•	•		•	•		•	•		

All prices ex works, excluding packaging.

Technical specifications serve as orientation values and are subject to tolerances due to production and manufacturing. Proper operation can only be guaranteed when using original Elma devices.

Elmasonic Accessories - Covers

Plastic lid

Dimension definition

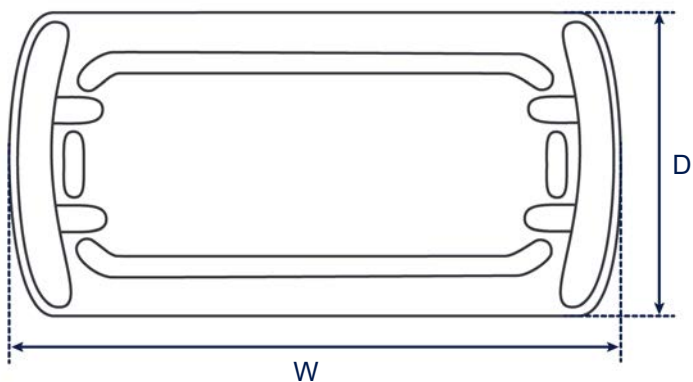

The drawings are merely included as a visualization aid and are not true to scale.

Technical specifications serve as orientation values and are subject to tolerances due to production and manufacturing. Proper operation can only be guaranteed when using original Elma devices.

Elmasonic Accessory - Covers

Noise protection covers

- reduce the noise of the ultrasonic cleaning by 40 % (500) and 54% (900)* and retain process vapours
- save energy and costs by reducing waste heat and collecting / recirculating the water vapour
- available as a retrofit kit for self-assembly and space-savings attached to the ultrasonic device



	500	900
Order number	1100349	1100292
External dimensions W / D / H (mm)	580 / 495 / 180	680 / 665 / 180
Height installed H ₁ (mm)	65	
Suitable for	500	900
• Elmasonic Med	•	•
• Elmasonic Select	•	•

Dimension definition

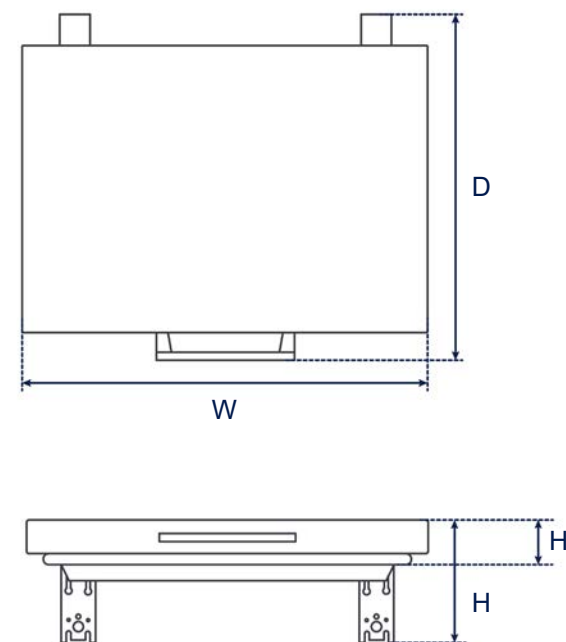

*Only when closed and without basket / load.

All prices ex works, excluding packaging.

The drawings are merely included as a visualization aid and are not true to scale.

Technical specifications serve as orientation values and are subject to tolerances due to production and manufacturing. Proper operation can only be guaranteed when using original Elma accessories.

Elmasonic Accessories - Holders and product carriers

Equipment holder

- made of stainless steel and with Rilsan-coated handles
- for holding laboratory vessels e.g. glass flasks up to 1000ml



Order number	1049704
Basket int. dimension W / D / H (mm)	195 / 95 / 75
Suitable for	
Elmasonic Med, Select, Easy, P	
60	1 x
120	2 x
180	2 x
300	4 x

Dimension definition

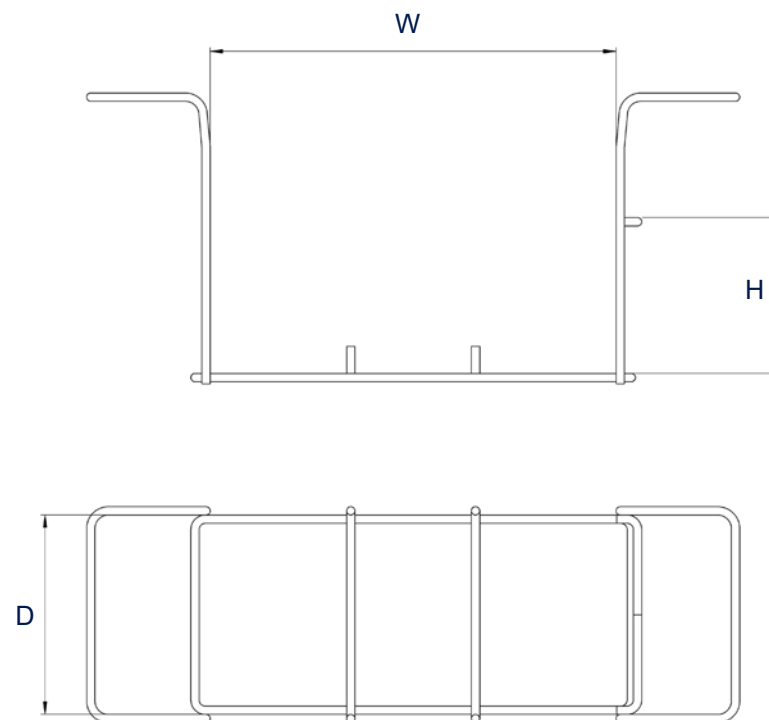

All prices ex works, excluding packaging.

The drawings are meant as a visualization aid and are not true to scale.

Technical specifications serve as orientation values and are subject to tolerances due to production and manufacturing. Proper operation can only be guaranteed when using original Elma Units.