

IKA

designed for scientists

EN



Disposable and reusable crushing systems

Disposable and reusable crushing systems

IKA has a long history of manufacturing batch mills and dispersers for a wide range of applications. For applications where cross-contamination between batches is a risk to analysis results or leads to a painstaking cleaning process, IKA's disposable systems offer unique designs and patented technologies for contamination-free results with minimal operator effort.

As IKA is committed to a sustainable future, all disposable chambers and tubes are made from recyclable materials: e.g. polypropylene, polyethylene. In addition, there are also reusable and thus autoclavable and dishwasher safe options available. Depending on the application requirements, users can decide whether they need to strictly avoid cross-contamination and therefore dispose of the vessel after use, or go for the reusable option to make laboratory processes more sustainable.



Personalized application support

In the IKA Application Center you can test each device yourself. Our experts analyze your processes and work with you to find out how your application can be optimized.

Worldwide service

To opt for IKA devices is also to opt for the excellent IKA service in your region. Our team is available worldwide for your service and application needs. Availability of spare parts is guaranteed for 10 years.

Do you have any questions?
Our service team is at your disposal:

2+1 years warranty*



More than just a single-use product

When it comes to avoiding the risk of cross-contamination, there is no better option than using consumables. But IKA's disposable products can do even more. After the grinding process, they provide a clean and efficient way to dispose of the sample or even use it as a storage chamber long after the test has been performed. For laboratories working with applications where sterility is important, there is the option of sterile-packaged versions of the tubes. Furthermore, reusable tubes are available that can be cleaned in the dishwasher and autoclaved.



4
/// Tube Mill control & Tube Mill 100 control



14
/// ULTRA-TURRAX® Tube Drive & Tube Drive P control



24
/// MultiDrive basic & control



32
/// Disposable Dispersing Elements

Tube Mill control & Tube Mill 100 control

/// The world's first disposable grinding system

Available in two sizes

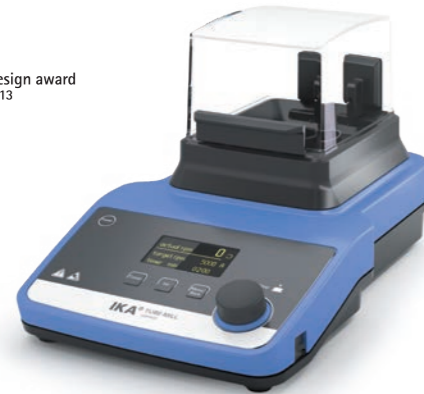

Tube Mill control
Ident No.: 0004180000



Tube Mill 100 control
Ident No.: 0020007144

The Tube Mill control is the first batch mill with the possibility to use disposable grinding chambers. It can grind a variety of soft, fibrous, hard and brittle samples in a short time without cross-contamination. IKA's patented universal mill works quickly, safely and delivers perfect, reproducible grinding results for your analyses. Sample preparation can be this simple and efficient.

Features



Interval grinding

With this batch mill, you can set individual grinding intervals depending on the sample.

YOUR BENEFITS

- › Thanks to individual grinding intervals, even light and oily samples can be comminuted more uniformly.

USB interface

The Tube Mill control and Tube Mill 100 control have an USB interface for exporting all selected parameters.

YOUR BENEFITS

- › Perfect control and documentation through data export.

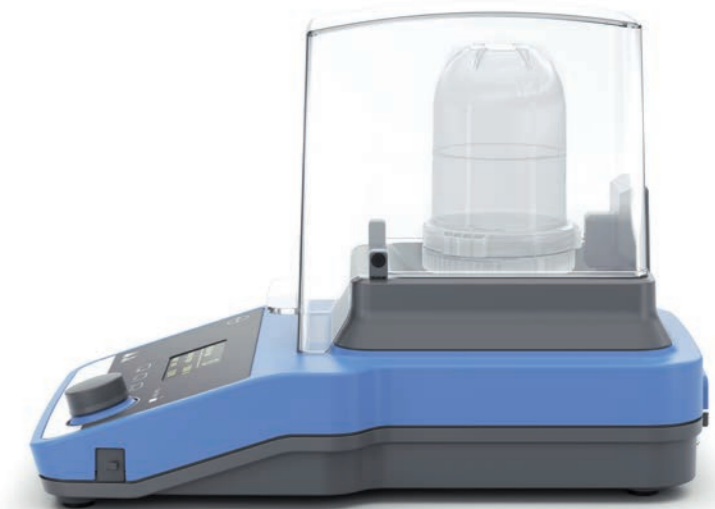

Magnetic safety hood

The grinding operation works only when the safety hood is closed. This closes magnetically and thus keeps reliably tight.

YOUR BENEFITS

- › Safe operation and more occupational safety



Grinding chambers

/// Disposable and reusable

With the Tube Mill and its associated grinding chambers, IKA offers a laboratory batch mill for benchtop operation that can be used for even the smallest sample sizes. In addition to the classic stainless steel beater, IKA also supplies titanium blades as well as curved stainless steel blades - especially suited for mixing fine powders.

Disposable grinding chambers

CHAMBER	PIECES / PACK	IDENT. NO.	USEABLE VOLUME (ML)	BEATER MATERIAL	COMPATIBILITY	
					Tube Mill control	Tube Mill 100 control
MT 40.10	10	0004425000	40	Stainless steel (AISI 301)	X	X
MT 40.100	100	0020001173	40	Stainless steel (AISI 301)	X	X
MT 100.10	10	0020008386	100	Stainless steel (AISI 301)		X
MT 100.50	50	0020006984	100	Stainless steel (AISI 301)		X
MT 40.10 steril	10	0020001984	40	Stainless steel (AISI 301)	X	X
MT 100.10 steril	10	0020012571	100	Stainless steel (AISI 301)		X
MT 40 P.10	10	0020017838	40	Stainless steel (AISI 301), curved (45° angle)	X	X
MT 40 P.100	100	0020011531	40	Stainless steel (AISI 301), curved (45° angle)	X	X
MTT 40.10	10	0020015380	40	Titanium	X	X
MTT 100.10	10	0020019576	100	Titanium		X

Reusable grinding chambers

CHAMBER	PIECES / PACK	IDENT. NO.	USEABLE VOLUME (ML)	BEATER MATERIAL	COMPATIBILITY	
					Tube Mill control	Tube Mill 100 control
MMT 40.1	1	0020003165	40	Stainless steel (AISI 301)	X	X
MMT 100.1	1	0020016315	100	Stainless steel (AISI 301)		X



YOUR BENEFITS

- › Avoid costs when working with small numbers of samples through multiple use
- › Reduce waste and consumables
- › Fast alternative to batch milling process
- › Small sample size compared to minimum requirements of batch mill

Material grinding chamber and cover: PA
 Material inner chamber: stainless steel (AISI 316L)
 Material beater: stainless steel (AISI 301)



YOUR BENEFITS

- › Save time when working with a large number of samples
- › No more cross-contamination
- › No health hazard from sample dust

Material grinding chamber: PP
 Max. hardness: 5 Mohs



The **disposable grinding chambers** are at the same time perfect storage containers. Grinding chambers can be labeled and either stored in a refrigerator or in a drying room. Reference samples can be re-analyzed and traced at any time. This helps to reduce waste.

The durable and environmentally friendly **reusable grinding chambers** can be quickly disassembled and cleaned in the dishwasher or autoclave. Wearing parts are already included in the scope of delivery and are easy to replace.

Multi-use milling chamber MMT

/// An alternative to disposable milling chambers

How MMT re-usable chambers improve your current method with no loss of time compared to consumable chambers:

Elevate your lab's productivity and environmental responsibility by maintaining a cycle of 12 MMT milling chambers. With this approach, 6 MMT chambers are dedicated to sample milling, while the other 6 can be effortlessly disassembled and prepared for a dishwasher or autoclave cycle. You can maintain a nearly identical hourly sample milling rate compared to disposable MT 40 chambers, while significantly reducing waste.

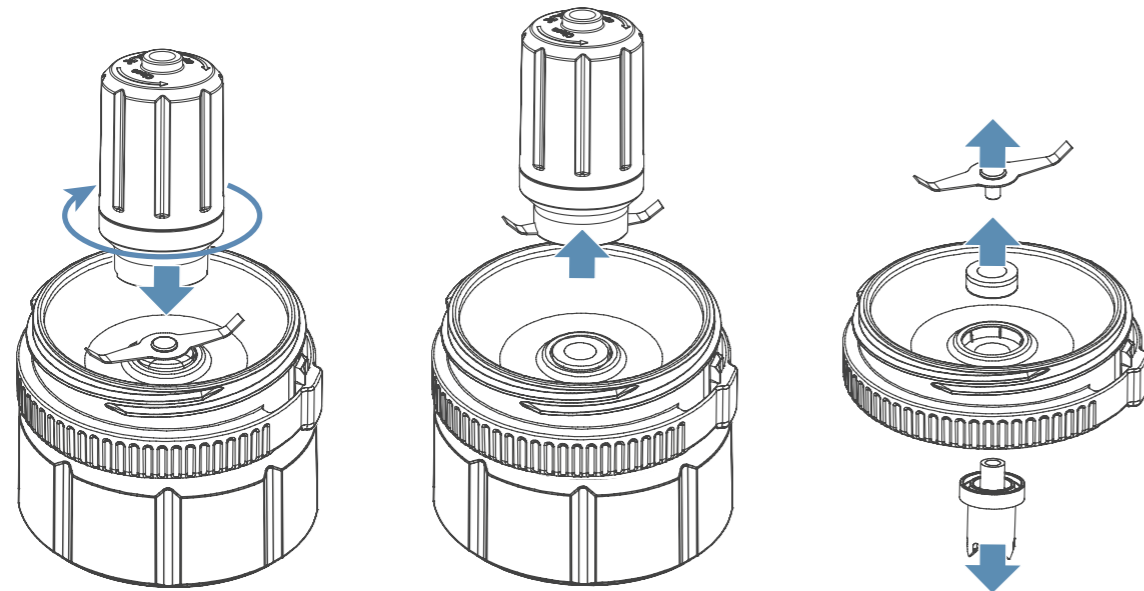

MMT chambers can be quickly disassembled with the supplied tools and prepared for the dishwasher or autoclave



Our **MMT multi-use milling chambers** are a real alternative for all laboratories that value sustainability and durable quality. Made of stainless steel (AISI 316L) and PA, the milling chambers are designed to withstand repeated experiments. Cleaning and sterilization are easily possible, as all components (except the sealing ring) are dishwasher and autoclave safe at 121 °C and 2 bar.

Included with each MMT chamber is a convenient **spare parts set** comprising 25 sealing rings, 5 beaters and 5 couplings. The beater and coupling should be replaced as needed. Their wear rate depends on the hardness of the processed samples. To ensure an airtight seal and prevent leakage, the sealing ring must be replaced after each grinding operation.



For those who want even more longevity, IKA offers the **A-MMT.100 Abrasion set for MMT 40.1 / 100.1** as accessory. A spare parts set for the MMT milling chambers that includes 100 sealing rings, 10 beaters and 10 couplings.

A-MMT.100 Abrasion set for
MMT 40.1 / 100.1
Ident. No.: 0020003378



Application

Tube Mill control is a highly versatile milling device suitable for a broad range of applications used in various industries. Amongst other applications, the mill is suitable for grinding seeds, such as corn and wheat. The ability to cool the sample with dry ice expands applications tremendously. The transparent grinding chamber and cover facilitate observation at all times.

Cryo grinding with dry ice

Tube Mill control can also be used to process moist, fatty, elastic and fibrous samples. Dry ice is introduced directly into the grinding chamber in order to embrittle the sample. The insulating effect of the plastic chamber allows minimal amounts of dry ice to be used. The cold remains in the milling chamber, allowing the user to handle the grinding chamber even after cooling. This greatly increases the range of applications for which the Tube Mill control can be used.



Packages



Tube Mill control Agriculture Solution
Ident. No. 0010013298

Scope of delivery:
Tube Mill control
MT 40.10 Disposable grinding chamber,
40 ml (10 pcs.)

Application: fast and effective analysis of seeds,
grains and foodstuffs.



Tube Mill 100 control Pharma Solution
Ident. No. 0010013309

Scope of delivery:
Tube Mill 100 control
MT 100.10 Disposable grinding chamber,
100 ml (10 pcs.)

Application: fast grinding of tablets and
capsules with no risk of cross-contamination

Our customers' application highlights

INDUSTRY / APPLICATION	DEVICE AND MILLING CHAMBER	PROCESS
Government / Forensic Research	Tube Mill 100 control MT 100 milling chamber	Crushing bones for DNA analysis. Tubes are sterilized with hydrogen peroxide to remove DNA fragments that interfere with PCR reaction.
Agrosience / Seed and Grain Milling	Tube Mill control MT 40 milling chamber	Milling of grains, seeds and plant materials for analysis
Cannabis Research / Cannabinoid Content Analysis	Tube Mill control MT 40 milling chamber	Milling of hemp and cannabis materials for analysis of › THC/CBD (Cannabinoids) › microbiology › foreign particles › heavy metals
Independent Testing Laboratories / Food Stuffs Analysis	Tube Mill control Sterile and non-sterile MT 40 milling chambers	Grinding of food, pet food, samples with food contact for nutritional and quality control analysis
Municipal Utilities / Quality Control – Sewage	Tube Mill 100 control MT 100 milling chamber	Milling of dry sewage sludge for quality control aspects

Technical data



TECHNICAL DATA	TUBE MILL CONTROL	TUBE MILL 100 CONTROL
Process type	batch	batch
Operating principle	Cutting / impact	Cutting / impact
Motor rating input	100 W	100 W
Motor rating output	80 W	80 W
Speed range	5000 – 25 000 rpm	5000 – 25 000 rpm
Speed deviation	2 ±%	2 ±%
Circumferential speed max.	65 m/s	65 m/s
Useable volume max.	40 ml	100 ml
Feed hardness max.	5 Mohs	5 Mohs
Feed grain size max.	10 mm	10 mm
Power-ON time	3 min	3 min
Mill feed can be cooled in milling chamber with dry ice	yes	yes
Dimensions (W x H x D)	180 x 170 x 300 mm	180 x 212 x 300 mm
Weight	2.7 kg	2.8 kg
Permissible ambient temperature	5 – 40 °C	5 – 40 °C
Permissible relative humidity	80 %	80 %
Protection class according to DIN EN 60529	IP 30	IP 30
USB interface	yes	yes
Voltage	220 – 240 / 100 – 120 / 100 V	220 – 240 / 100 – 120 / 100 V
Frequency	50/60 Hz	50/60 Hz
Power input	100 W	100 W

FAQ

1. How finely can the samples be ground?

The samples can be ground to a particle size of 1 – 100 µm depending on the sample.

2. What is the minimum quantity in the grinding chamber?

Even a single grain can be milled with the Tube Mill control.

3. How large may the individual feed grain size be?

The individual specimen pieces must not be larger than 1 cm in diameter.

4. Which model of Tube Mill control is suitable for me?

If you only need to grind small sample quantities of up to 40 ml, the Tube Mill control is completely sufficient. For larger or alternately large sample quantities, it is best to opt for the Tube Mill 100 control. Here you can use grinding chambers with 40 ml as well as those with 100 ml.

5. When does the use of disposable grinding chambers make sense?

The more samples you have to grind, the more worthwhile it is to use disposable cups. You save a lot of time because there is no need for time-consuming cleaning of the chambers. Since this also prevents cross-contamination, your results are also more reliable.

6. When to use titanium or curved knives?

Curved knives reduce the accumulation of ground specimen material at the edge of the chamber and thus ensure better mixed and ground specimens. Titanium knives are intended for applications where no heavy metals (Cr or Ni) resulting from abrasion of the stainless steel beater may be permitted to contaminate the sample.

7. How do I achieve the desired grind?

The length of the grinding process determines the degree of grinding. The finer your sample needs to be, the longer it should be ground. The necessary grinds vary from sample to sample.

8. Which cleaning methods can be used for the grinding chambers?

Before single use, the grinding bowls can be autoclaved.

9. What materials are the grinding chamber, beater and seal made of?

The disposable grinding chambers are made of PP, the blade is made of AISI 301 stainless steel and the seal is made of PA. For the reusable grinding chambers, the grinding bowl and lid are made of PA, and the inner vessel is made of stainless steel (AISI 316L).

10. Can the grinding chambers be used with dry ice?

Yes, the grinding chambers can be used with dry ice.

11. Can the disposable grinding chambers be used several times?

The disposable grinding chambers should only be used once to exclude cross-contamination.



ULTRA-TURRAX® Tube Drive & Tube Drive P control

/// World's first universal disposable disperser system



ULTRA-TURRAX®
Tube Drive P control
Ident No.: 0025005981

ULTRA-TURRAX®
Tube Drive
Ident No.: 0003646000

The ULTRA-TURRAX® Tube Drive disperser system provides protection and security for infectious sample materials, toxic and high-odor substances under defined conditions. Test procedures are easily duplicated with no cross-contamination between samples. The sample containers (tubes) can be easily attached to the drive unit.

The even more powerful motor of the ULTRA-TURRAX® Tube Drive P control allows the unit to run at a higher speed for more intensive mixing. With the turbo button, speeds of up to 8,000 rpm can be reached for short periods. The ULTRA-TURRAX® Tube Drive P control also offers the option of changing the direction of rotation to optimize the mixing and crushing result achieved. The USB interface enables operation and data storage on the PC.



Hermetically sealable sample tubes

Disposable tubes

The sealable disposable tubes have been optimized for your application.

YOUR BENEFITS

- › Less cleaning required and the risk of cross-contamination is ruled out
- › Reproducible test conditions

Programmable test conditions

Time, energy, volume: You specify and systematically program the test conditions (UTTD P control only).

YOUR BENEFITS

- › Frequently used parameters are stored in your library



Adjustable change in direction of rotation

When, and how often, the direction of rotation should be changed is very easily set using the clear and multilingual menu (UTTD P control only).

YOUR BENEFITS

- › Optimized mixing and crushing results

Turbo button

Over short periods, rotational speeds of up to 8000 rpm can be achieved (UTTD P control only).

YOUR BENEFITS

- › Even more intensive mixing, dispersing or grinding at your fingertips

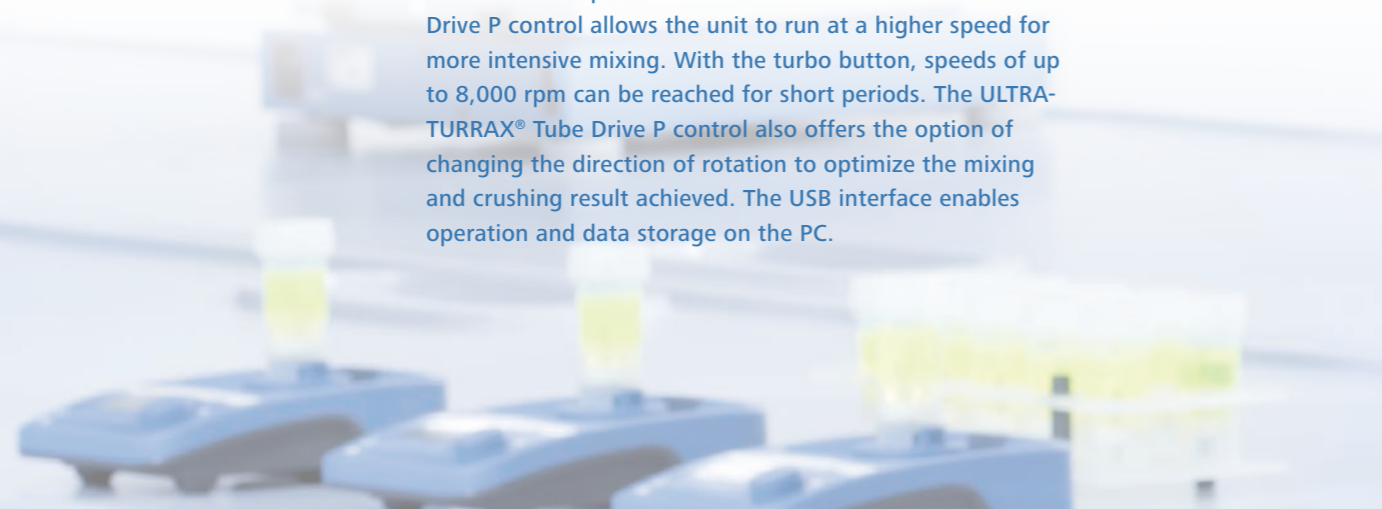



ST TUBE
Tube with stirring device

- Suitable for:
- › Mixing
 - › Stirring
 - › Extractions
 - › Preparation of soil sample suspensions

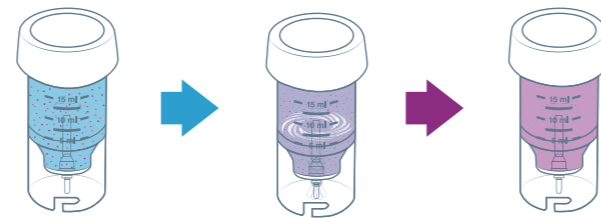

DT TUBE
Tube with rotor-stator element

- Suitable for:
- › Dispersion
 - › Homogenization
 - › Suspensions
 - › Pharmacokinetics
 - › Metabolism studies
 - › Diagnosis

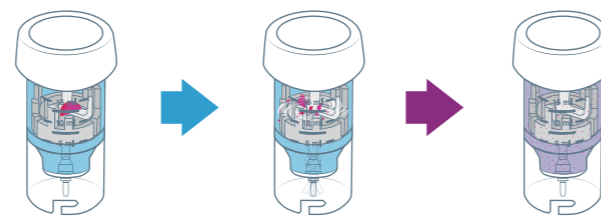

BMT G / S TUBE
Tube for grinding with glass balls (G) or with stainless steel balls (S)

- Suitable for:
- › Dry milling of dry and brittle samples (e.g. kaolin, gypsum, colored pigments, tablets)
 - › Cell maceration
 - › Processing of materials mixed with fluids

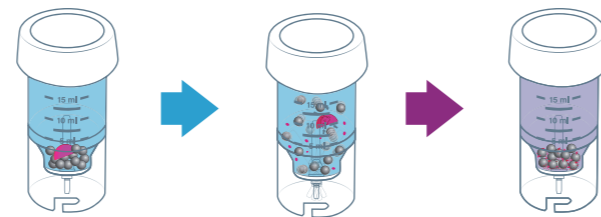

DIS TUBE
Tube with dissolver blade

- Suitable for:
- › Dissolving samples in different solvents
 - › Crushing, mixing, dissolving

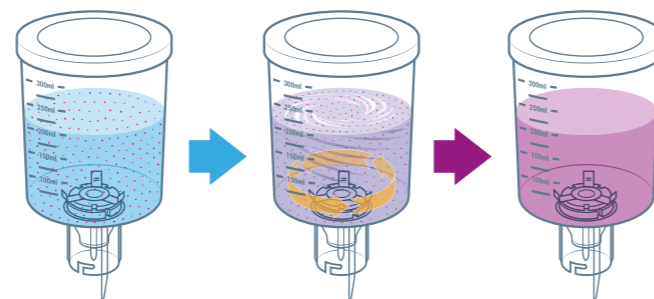

All tubes are also available with a pierceable membrane and gamma-sterilized

BMT-20-S-IVD

/// For use in human medicine



BMT-20-S-IVD* is a universally applicable disposable mixing vessel for use in human medicine and infection diagnostics. The gamma-sterilized tube contains a stirring unit, 10 stainless steel balls and 5 ml of saline solution and has a screw-on cover with pierceable membrane. BMT-20-S-IVD facilitates and improves microbiological and molecular-biological analysis of patient samples such as tissue or intraoperative samples.

REDUCED RISK OF CONTAMINATION

No cross-contamination as sample is directly ground inside the vessel, no multiple opening of sample vessel required.

TIME SAVING

Disposable system, shorter sample preparation times, no cleaning of additional vessels.

TRACEABILITY

One single process for transport, grinding / homogenization and storage.



CHAMBER	PIECES / PACK	IDENT. NO.	USEABLE VOLUME (ML)		COMPATIBILITY	
					ULTRA-TURRAX® Tube Drive	ULTRA-TURRAX® Tube Drive P control
ST TUBES WITH STIRRING ELEMENT						
ST-20	25	0003703000	20	Tube with stirring element	X	X
ST-20-M-gamma	20	0003700500	20	+ sterile, membrane lid	X	X
ST-50	10	0003699500	50	Tube with stirring element	X	X
ST-50-M-gamma	10	0003701500	50	+ sterile, membrane lid	X	X
DT TUBES WITH ROTOR-STATOR ELEMENT						
DT-20	25	0003703100	20	Tube with rotor-stator element	X	X
DT-20-M-gamma	20	0003700600	20	+ sterile, membrane lid	X	X
DT-20 eco	25	0020003207	20	Tube with rotor-stator element	X	X
DT-50	10	0003699600	50	Tube with rotor-stator element	X	X
DT-50-M-gamma	10	0003701600	50	+ sterile, membrane lid	X	X
DT-50 eco	10	0020003213	50	Tube with rotor-stator element	X	X
BMT G S TUBES FOR GRINDING WITH GLASS (G) OR STAINLESS STEEL (S) BALLS						
BMT-20-S	25	0003703200	20	Tube with stirring element + stainless steel balls	X	X
BMT-20-G	25	0003703300	20	+ glass balls	X	X
BMT-20-S-M-gamma	20	0003700701	20	+ stainless steel balls sterile, membrane lid	X	X
BMT-20-G-M-gamma	20	0020017448	20	+ glass balls sterile, membrane lid	X	X
BMT-50-S	10	0003699700	50	+ stainless steel balls	X	X
BMT-50-G	10	0003699800	50	+ glass balls	X	X
BMT-50-S-M-gamma	10	0003701700	50	+ stainless steel balls sterile, membrane lid	X	X

CHAMBER	PIECES / PACK	IDENT. NO.	USEABLE VOLUME (ML)		COMPATIBILITY	
					ULTRA-TURRAX® Tube Drive	ULTRA-TURRAX® Tube Drive P control
TUBES WITH DISSOLVER ELEMENT AND MEMBRANE LID						
DIS-50-S-M	10	0020016316	50	Tube with dissolver blade	X	X
DIS-50-T-M	10	0020016317	50	Tube with titanium dissolver blade	X	X
DIS-300-S-M.10	10	0020016318	300	Tube with dissolver blade		X
DIS-300-S-M.50	50	0020017313	300	Tube with dissolver blade		X
TUBES WITH DISSOLVER ELEMENT						
DIS-300-S.10	10	0020026959	300	Tube with dissolver blade		X
DIS-300-S.50	50	0020026960	300	Tube with dissolver blade		X
BALL MILLING TUBES						
BMT-20-S-IVD1.50	50	0020103143	50	+ IVD label, stainless steel balls, 5 ml NaCl solution, membrane lid, single sterile packaging	X	X
BMT-20-S-IVD.50	50	0020027186	50	+ IVD label, stainless steel balls, 5 ml NaCl solution, membrane lid, double sterile packaging	X	X



ST-20



ST-50-M



DT-20



DT-50-M



BMT-20-G-M



BMT-20-S-IVD.50



DIS-50-S-M



DIS-300-S-M

Packages



ULTRA-TURRAX® Tube Drive P control Workstation

Ident. No. 0025005836

Scope of delivery:
 ULTRA-TURRAX® Tube Drive P control
 ST-20 Stirring tubes, 20 ml, 3 pcs.
 DT-20 Dispersing tube, 20 ml, 1 pc.
 Glass balls (6.0 mm) for BMT tubes
 Stainless steel balls (5.0 mm) for BMT tubes



UTTD control Pharma Solution

Ident. No. 0010013297

Scope of delivery:
 ULTRA-TURRAX® Tube Drive P control
 DIS-300-S-M.10 Dissolver tubes, 300 ml, 10 pcs.

Application: tablet grinding and dissolving for subsequent analysis.



UTTD control IVD Solution

Ident. No. 0010013008

Scope of delivery:
 ULTRA-TURRAX® Tube Drive P control
 BMT-20-S-IVD.50 Ball milling tube, double sterile packed, IVD label, 20 ml, 50 pcs.

Application: microbiological and molecular biological analysis of patient samples.



UTTD control Life Science Solution

Ident. No. 0010013296

Scope of delivery:
 ULTRA-TURRAX® Tube Drive P control
 DT-20 Dispersing tubes, 20 ml, 25 pcs.

Application: single-use homogenization of tissue, cartilage and bone samples in life science and biological applications.



UTTD basic IVD Solution

Ident. No. 0010013007

Scope of delivery:
 ULTRA-TURRAX® Tube Drive P control
 BMT-20-S-IVD.50 Ball milling tube, double sterile packed, IVD label, 20 ml, 50 pcs.

Application: microbiological and molecular biological analysis of patient samples.



Our customers' application highlights

INDUSTRY / APPLICATION	TUBES	PROCESS
Clinical Diagnostic Lab	Gamma-sterilized or IVD certified grinding tubes	Grinding of hair, bone and blood for DNA extraction
FDA / CDC / CIQ Food, Medicine Analysis	BMT – ball mill tubes with stainless steel balls	Grinding samples with the intention of looking for pesticide residue
Hospitals	IVD certified BMT ball mill tubes	Milling human tissue post operation
Tissue Bank	Gamma Sterilized DT-20	Research and manufacturing HCT/P
University Nutritional Testing	ST-20 stirring tube	Fat content analysis in dairy product – improved method from previous extraction techniques of sample preparation

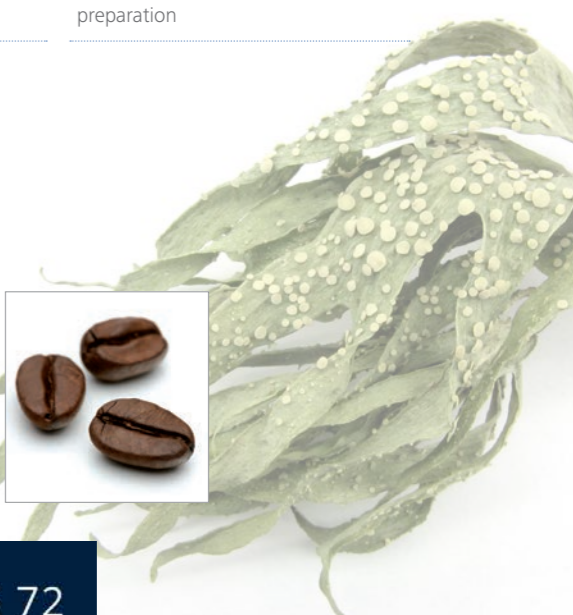

Technical data



TECHNICAL DATA	ULTRA-TURRAX® Tube Drive P control	ULTRA-TURRAX® Tube Drive
Motor rating input	36 W	20 W
Motor rating output	28 W	17 W
Viscosity max.	5,000 mPas	5,000 mPas
Speed	min. 400 rpm max. 8,000 rpm	min. 300 rpm max. 6,000 rpm
Reversible direction of rotation	Yes	No
Speed deviation	3 %	10 %
Speed display	OLED	Scale
Speed control	10 rpm steps	Stepless
Noise without element	50 dB(A)	50 dB(A)
Process type	Batch	Batch
Timer	Yes	No
Timer display	OLED	–
GENERAL DATA		
Weight	1.3 kg	0.75 kg
Dimensions (W x H x D)	122 x 54 x 178 mm	100 x 40 x 160 mm
Permissible ambient temperature	5 – 40 °C	5 – 40 °C
Permissible relative humidity	80 %	80 %
Protection class according to DIN EN 60529	IP 20	IP 20
Interface	USB	–
Voltage	100 – 240 V	100 – 240 V
Frequency	50/60 Hz	50/60 Hz
Current consumption	1,500 mA	1,500 mA

DT TUBE

Tube lid

Rotor

Stator

Rotor drive

Pestle

Membrane

Membrane fixation

Vessel

FAQ | ULTRA-TURRAX® Tube Drive

1. What material are the tubes made of and against which solvents are they resistant?

The tubes are manufactured from polypropylene (PP), polyetheretherketone (PEEK), a thermoplastic elastomer (TPE), polyethersulfone (PES) and polyetheretherketone with teflon (PEEK + PTFE). The balls are manufactured from either stainless steel AISI 304 or soda-lime glass. All plastic materials conform to the FDA regulations. The parts have a good stability against weak acids, chlorides, hypochlorides and many other chemicals.

2. What volumes can be processed in the tubes?

Tubes are available in two sizes: 20 ml and 50 ml. The working volume range is from 2 to 50 ml.

3. What does cross-contamination mean?

Cross-contamination refers to the contamination of a sample with a second sample. For example, residue on a processing tool may be transferred into future tests. Because the UTDD tubes are closed and used only one time, cross-contamination is prevented.

4. Why can I use the tubes only once?

The tubes are intended for single use to prevent cross-contamination and avoid the need for cleaning. Also, the tube membrane is made of a flexible plastic which can only be exposed to high mechanical stress for a limited time.

5. Can the tubes be used several times or for longer periods (>30 min)?

IKA does not recommend using tubes multiple times or for periods longer than 30 minutes. Tubes may leak and cause fluid to pass into the drive. This may lead to serious drive damage or failure.

6. Can the balls of the BMT Tubes be used for several times?

After each experiment, balls can be cleaned, sterilized and reused.

7. Can other ball sizes and materials be used for the BMT Tubes?

It is possible to use balls made of other materials with the UTDD (e.g. ceramic). The size of the balls is variable, but should not exceed a diameter of 6 mm. For cell disruption, IKA recommends using balls with a diameter < 2 mm.

8. Are the sterilized tubes really sterile?

The sterilized tubes are first blister packed and then gamma sterilized. To further guarantee sterility, an expiration date is printed on the packaging. On a rotational basis, revalidation is performed to ensure the tubes are sterile in accordance with ISO 11137-1.

9. Can I use the UTDD for my special application?

Please consult the IKA application database to see if your application has already been tested. If no similar items have been tested, you may send a sample to our test laboratory. We will be happy to test, analyze and report results directly to you. If you prefer, we will send you a demo UTDD unit to test in the privacy of your own lab. IKA provides these services at no cost to the customer.

10. What are the advantages of the UTDD against the conventional dispersing systems?

Safety: The hermetically sealed tubes prevent the user from coming in contact with toxic or infectious samples.
Storage: The tubes are used only once and can then be used for sample storage.
Disposable: Tubes can be discarded after one use. No time or money is wasted on expensive sterilization of a dispersing tool.

11. Why is the reproducibility better than similar systems?

Because the tests are carried out in a defined closed vessel (tube), the conditions are always identical. In addition, the test time and the speed can be precisely controlled. With the UTDD control, application programs can be stored so that the experiment conditions can be precisely duplicated.

12. What are the benefits of the turbo and reverse buttons on the UTDD control?

The turbo and reverse functions provide superior mixing and grinding effects. The additional functions provide the ability to achieve good process results with samples that are difficult to process with the basic version of the UTDD.

13. Are the non-sterile tubes autoclavable?

No, the non-sterile tubes are not autoclavable.

MultiDrive basic & control

/// The all-rounder in coarse and fine crushing



MultiDrive basic
Ident No.: 0025002638*



MultiDrive control
Ident No.: 0025002643*

MultiDrive crushes, grinds and even thoroughly mixes hard, soft or fibrous samples. A 1000-watt output and a large number of suitable vessels ensure perfect solution to every new challenge encountered in the laboratory. It is suitable for applications in pharmacy, medicine, the food industry, biology or the biomass sector.

There is a basic and control version available. MultiDrive basic offers the option of interval programming and has integrated cooling. MultiDrive control is particularly handy for users thanks to its additional functions: it measures the temperature in the vessel in real time and weighs the samples directly in the grinding beaker. This means that laborious decanting is no longer necessary. A USB interface is available for easy actuation and documentation respectively. In addition, MultiDrive control has a clear TFT display and can be operated with the disposable tubes BT 250 and MT 150.

Features

High performance

Availability of variable rotational speeds, ranging from 3000 rpm to 20 000 rpm, and a 1000 Watt output.

YOUR BENEFITS

- › Excellent crushing performance for a wide range of samples



Interval operation

The option of interval programming is simple to activate at the press of a button. Interval operation is an asset during the coarse crushing of hard samples or for extra thorough blending.

YOUR BENEFITS

- › Prevention of heat generation and finely ground samples

TFT-display

A clear TFT-display guarantees user-friendly operation

YOUR BENEFITS

- › All settings required are easily accessible



Disposable and reusable tubes

The MultiDrive with its BT 250 blender tube and MT 150 milling tube offers a new powerful solution within IKA's single-use crushing product lineup. With its 1000 W motor it offers more power than the ULTRA-TURRAX® Tube Drive and Tube Mill control.

The 250 ml blender tube and 150 ml milling tube offer a larger volume option as well as are able to handle both dry (MT 150) and wet (BT 250) sample types. Wet samples and high moisture containing samples run no risk of leaking from the liquid tight vessels.

YOUR BENEFITS

- › Both tubes are autoclavable and thus prevent cross-contamination effectively even when used multiple times.
- › Spare seals extend the service life of both tubes.
- › An integrated RFID chip ensures the perfect lifespan. When the seal or tube needs replacing, the mill will give an indication.
- › MultiDrive control automatically recognizes, if the tube is covered by the mandatory protective housing – otherwise it won't start.



FOR WET SAMPLES Blending tube

BT 250.5 is a disposable tube with a cross-shaped stainless steel beater and flow breakers.

It is ideally suited for wet blending.



FOR DRY SAMPLES Mixing tube

MT 150.5 is a disposable tube with a typical stainless steel beater.

It is ideally suited for grinding dry samples.



TECHNICAL DATA	BT 250.5	MT 150.5
Quantity	5 tubes and 5 spare seals per package; reactivation codes included	
Useable volume max.	250 ml	150 ml
Feed grain size / Feed hardness max.	10 mm / 5 Mohs	
Material in contact with medium	Stainless steel, PA, PC, PTFE, silicone	
Autoclavable	Yes	
FDA compliant	Yes	

Only usable in combination with TC 1 protective housing. TC 1 is available as an accessory.



PRODUCT	DESCRIPTION	IDENT. NO.
TC 1	Protective housing for MT 150 and BT 250	0020023489
MT 150.5*	Milling tube, autoclavable, 150 ml, 5 pcs. (incl. TS 1)	0020023173
BT 250.5*	Blending tube, autoclavable, 250 ml, 5 pcs. (incl. TS 1)	0020023174
TS 1	Spare seal with reactivation code, 5 pcs.	0020023490

* TC 1 protective housing is mandatory to operate the tube



Packages



MultiDrive control BT Package
Ident. No. 0010007086

Scope of delivery:
MultiDrive control
MultiDrive TC 1 Protective housing
MultiDrive BT 250.5 Blending tube,
autoclavable, 250 ml, 5 pcs.

Application: blending and mixing of wet and moist samples



MultiDrive control MT Package
Ident. No. 0010013296

Scope of delivery:
MultiDrive TC 1 Protective housing
MultiDrive MT 150.5 Milling tube,
autoclavable, 150 ml, 5 pcs.

Application: grinding of dry samples



Application

Coarse and fine crushing plays a role in a diverse range of industries. The all-rounder MultiDrive therefore is ideally oriented for various crushing tasks in the following fields of application:



Our customers' application highlights

INDUSTRY / APPLICATION	MILLING CHAMBER	PROCESS
Animal disease control	MultiDrive BT 250.5	Grinding 50 g of fresh meat per batch
Food Heavy metal analysis	MultiDrive BT 250.5	Grinding and homogenizing of dried corn kernels with max. temperature of 50 °C during crushing
Ion analysis	MultiDrive BT 250.5	Grinding of fragments after curing of epoxy glue. 10 – 20 g per batch
Medicine	MultiDrive BT 250.5	Crushing of external use plaster in order to separate medicine from the plaster part
Agriculture	MultiDrive MT 150.5	Milling of lemon peel, solid olive oil waste and seaweed



Technical data | MultiDrive basic and control

TECHNICAL DATA	MultiDrive basic	MultiDrive control
Operating principle	Cutting / impact	Cutting / impact
Feed hardness max.	5 Mohs (9 Mohs with hard metal knife)	5 Mohs (9 Mohs with hard metal knife)
Feed grain size max.	BL: 50 mm MI: 7 mm	BL: 50 mm MI: 7 mm MT/BT: 10 mm
Useable volume max.	BL: 2000 ml MI: 250 ml / 400 ml	BL/DI: 2000 ml MI: 250 ml / 400 ml MT: 150 ml BT: 250 ml
Material of grinding vessels	BL: PCTG MI: Stainless steel	BL / DI / MT / BT: PCTG MI: Stainless steel
Material beater / cutter	BL / MI: Stainless steel MI: Hard metal	BL / DI / MT / BT: Stainless steel MI: Hard metal
Speed	Min. 3000 rpm Max. 20 000 rpm	Min. 3000 rpm Max. 20 000 rpm
Setting of operation time	0 – 5 min	0 – 5 min
Timer / Counter	Yes	Yes
Intermittent operation	Yes	Yes
Programmable	No	Yes
Cooling water connection by milling chamber	Yes	Yes
Milling with dry ice by milling chamber	Yes	Yes
Temperature measurement	No	Yes*
Vessel recognition	No	Yes*
Weighing function	No	Yes
GENERAL DATA		
Voltage	220 – 240 V	220 – 240 V
Frequency	50 / 60	50 / 60
Motor	brushless	brushless
Motor rating input	1000 W	1000 W
Motor rating output	800 W	800 W
Display	LCD	TFT
USB interface	Yes	Yes
Bluetooth	No	Yes
Weight	10 kg	10 kg
Dimensions (W x H x D)	300 x 450 x 250 mm	300 x 450 x 250 mm
Permissible ambient temperature	5 – 40 °C	5 – 40 °C
Protection class according to DIN EN 60529	IP 31	IP 31

BL: Blender vessel
MI: Milling chamber
DI: Dispersing vessel
MT: Milling Tube
BT: Blender Tube

*Only for vessels with "T"

FAQ

1. Which of the MultiDrive disposable tubes is suitable for me?
This depends on the kind of sample you want to process. If you are processing wet samples we recommend the blending tube BT 250.5. It is equipped with a cross-shaped stainless steel beater and flow breakers. For dry samples you better opt for the mixing tube MT 150.5 with a typical stainless steel beater. Thanks to the transparent plastic of the two tubes, the grinding material can be continuously observed.

2. How finely can the samples be ground with the MultiDrive BT and MT Tubes

Sample fineness depends on the material properties of the sample. A particle size distribution is to be expected. To further distinguish the fineness of the sample, material separation techniques like sieve shaking can be used after the grinding process.

3. What is the maximum quantity in the MultiDrive BT and MT Tubes?

For the BT tubes the maximum quantity that can be processed is 250 ml, for the MT tubes it is 150 ml.

4. How large may the individual feed grain size for the use of a MultiDrive be?

The individual specimen pieces must not be larger than 1 cm in diameter.

5. How do I achieve the desired grind with the MultiDrive BT and MT Tubes?

The length of the grinding process determines the degree of grinding. The finer your sample needs to be, the longer it should be ground in the MultiDrive. The necessary grinds vary from sample to sample. If temperature is a topic for you we recommend do use the interval mode.

6. Which cleaning methods can be used for the MultiDrive BT and MT Tubes?

Before single use, the MultiDrive BT and MT Tubes can be autoclaved.

7. What materials are the MultiDrive BT and MT Tubes, beater and seal made of?

The MultiDrive BT and MT Tubes are made of stainless steel, PA, PC, PTFE and silicone

8. Can the MultiDrive BT and MT Tubes be used with dry ice?
Yes, the tubes can be used with dry ice.

9. Can the MultiDrive BT and MT Tubes be used several times?
Both tubes are reusable. However, the maximum working time is 6 minutes. After 6 minutes you need to exchange the sealing in order to ensure further impermeability. If you need to exclude cross-contamination we strongly recommend to dispose the tubes after usage.



Disposable Dispersing Elements

/// Cross-contamination free homogenizing and processing

The KS series of disposable dispersing elements are a unique addition to the long established IKA ULTRA-TURRAX® dispersing product line. For applications where the risk of cross-contamination is paramount the KS dispersing elements offer a single-use and disposable option for the IKA dispersers. Available in packs of 12 or 24 pieces, constructed of FDA approved plastic materials and with the ability to be easily sterilized, the KS series of dispersing elements offer multiple solutions to some of the laboratory homogenizing applications' toughest challenges. These plastic dispersing elements are also recommended in applications where samples are incompatible with stainless steel.



Perfect complement:
S 18/25-ET50 disposable tube
 Ident No.: 0003452500

The 50 ml disposable tube made of PP was designed to be attached onto the plastic dispersing elements of the disperser series T 18 and T 25 digital ULTRA-TURRAX®. It allows dispersing in a closed system (splash guard).



T 10 basic ULTRA-TURRAX®

T 18 digital ULTRA-TURRAX®

S 10 D - 7 G - KS - 65
 Ident No.: 0020002076

S 10 D - 7 G - KS - 110
 Ident No.: 0020002075

S 18 D - 10 G - KS
 Ident No.: 0003452400

Suitable drive	T 10 basic	T 10 basic	T 18 digital / T 18 brushless digital
Working range	1 – 40 ml	1 – 20 ml	10 – 100 ml
Diameter	7 mm	7 mm	10 mm
Immersion depth	20 – 65 mm	20 – 90 mm	15 – 85 mm
Material	PC, PSU	PC, PSU	PC, PEEK Plastic materials used approved by FDA
Max. temperature	100 °C	100 °C	100 °C
Autoclavable	Yes	Yes	Yes
Scope of delivery	24 pcs	24 pcs	12 pcs



T 18 brushless digital ULTRA-TURRAX®

T 25 / T 25 easy clean ULTRA-TURRAX®

S 18 D - 14 G - KS
 Ident No.: 0003452300

S 25 D - 10 G - KS
 Ident No.: 0003452200

S 25 D - 14 G - KS
 Ident No.: 0003452100

Suitable drive	T 18 digital / T 18 brushless digital	T 25 / T 25 easy clean	T 25 / T 25 easy clean
Working range	10 – 500 ml	10 – 100 ml	10 – 500 ml
Diameter	14 mm	10 mm	14 mm
Immersion depth	15 – 85 mm	15 – 85 mm	15 – 85 mm
Material	PC, PEEK Plastic materials used approved by FDA	PC, PEEK Plastic materials used approved by FDA	PC, PEEK Plastic materials used approved by FDA
Max. temperature	100 °C	100 °C	100 °C
Autoclavable	Yes	Yes	Yes
Scope of delivery	12 pcs	12 pcs	12 pcs

Application

RNA/DNA extraction and separation

Sample disruption is a necessary early step in the isolation of RNA, DNA, and proteins. Rotor stator homogenizers are an ideal physical method used to disrupt the sample since thorough homogenization of cells or tissues is an essential step in DNA/RNA isolation that prevents both loss and degradation of genetic material.

TISSUE HOMOGENIZATION UNDER STERILE CONDITIONS

Muscle tissue
Heart tissue
Lung tissue
Animal tissue
Cell lysis
Tissue biopsies

BIOTECHNOLOGY

Bacterial suspensions
Fungal spores
Hemicellulase blending

PHARMACEUTICAL MILLING AND MICRONIZATION

Enzymatic emulsions
Vaccine emulsions
Powder dispersion

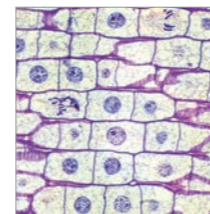

Our customers' application highlights

INDUSTRY	DEVICE AND TOOL	PROCESS
Biology and medical R&D labs in universities and hospital	Disperser: T 10 Dispersing elements: S 10 D	› Cell homogenization › Homogenizing animal and plant tissues
Fast testing in mobile labs of Government Health organizations (FDA and CDC)	Disperser: T 18 and T 25 Dispersing elements: S 18 D and S 25 D	› Cell homogenization of clinical specimens
Biotechnology and seed culture	Disperser: T 18 Dispersing elements: S 18 D	› Dispersing fungal pellets for seed culture
Proteomics	Disperser: T 18 Dispersing elements: S 18 D	› Breakdown of amniotic sac for hormone extraction and purification

FAQ

1. How many times can I use a single KS disposable dispersing element?

The tools are ideally appropriate for a single-use. However they can be reused several times, depending on the application. However, the lifetime of these dispersing elements is limited.

2. Are the KS disposable dispersing elements sterile?

The dispersion tools are not sterile, but they can be sterilized before use. Different sterilization techniques allowed are found in the manual.

3. How long can I operate the IKA disperser with the KS disposable dispersing element?

This depends on the RPM used. If using the maximum 25 000 rpm – do not operate for more than 60 seconds at a time. Longer application times bring no further improvements except to generate more heat.

4. Are the materials of construction approved by the FDA?

The plastic materials used are approved by FDA (Food and Drug Administration Compliance certificates can be provided upon request).

5. What is the difference between the dispersing elements with different diameters?

Dispersing elements with larger diameters are able to process larger sample volumes.

6. Can the dispersing elements be used directly inside of a 1.5 / 2.0 ml microtube?

Yes, all the dispersing elements with a diameter of 10 mm and below can be used to process samples directly inside of these microtubes.

Further accessories
can be found at
www.imlab.eu



designed for scientists

Everything for your Lab

IKA is your reliable partner in laboratory, analysis and process technology. When it comes to applications in the areas of stirring, mixing, tempering, distilling or grinding, market leaders rely on our proven products and technology. We are continually working to further develop our portfolio according to the needs of our customers. Building on this, we network our products and services to create holistic, application-oriented solutions and enable our customers to achieve the best possible results and step into the digital age.



BIOREACTORS



MIXING



HEATING / COOLING /
TEMPERING



LIQUID HANDLING



MEASURING VISCOSITY



VACUUM TECHNOLOGY



CRUSHING



LABORATORY SOFTWARE



SEPARATION



ELECTROCHEMISTRY
FLOW CHEMISTRY



REACTOR SYSTEMS



CALORIMETRY