

IKA

designed for scientists

IKA Trayster digital



IKA Trayster basic



Betriebsanleitung	DE	3
Operating instructions	EN	10
Mode d'emploi	FR	17
Инструкция по эксплуатации	RU	24
使用说明	ZH	31

Indicaciones de seguridad	ES	39
Veiligheidsinstructies	NL	39
Norme di sicurezza	IT	40
Säkerhetsanvisningar	SV	41
Sikkerhedshenvisninger	DA	42
Sikkerhedsanvisninger	NO	42
Turvallisuusohjeet	FI	43
Normas de segurança	PT	44
Υποδείξεις ασφαλείας	EL	45

Wskazówki bezpieczeństwa	PL	45
Bezpečnostní upozornění	CS	46
Biztonsági utasítások	HU	47
Varnostna navodila	SL	48
Bezpečnostné pokyny	SK	48
Ohutusjuhised	ET	49
Drošības Norādes	LV	50
Saugos Reikalavimai	LT	51
Инструкции за безопасност	BG	51
Indicații de siguranță	RO	52

IKA Trayster basic

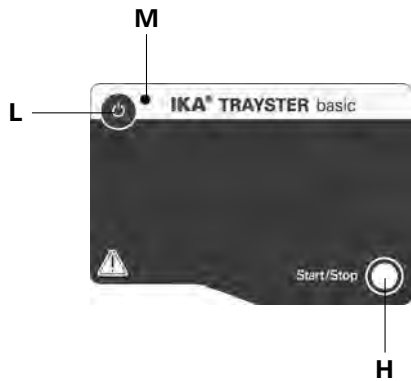
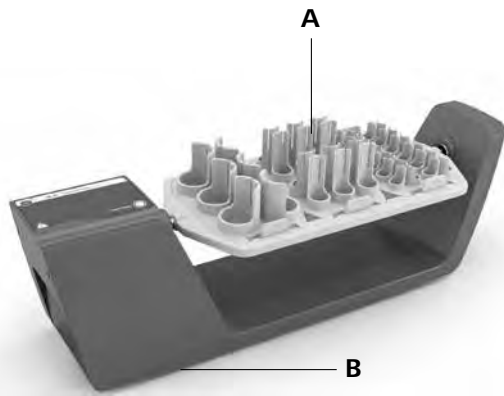

IKA Trayster digital

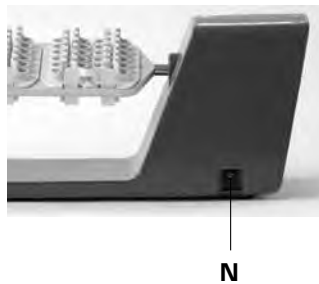
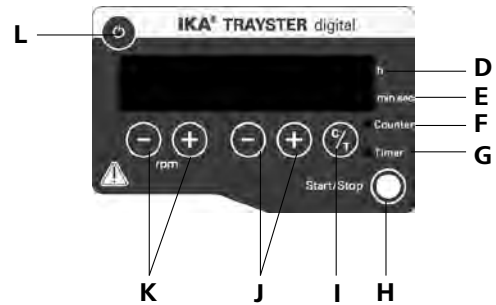
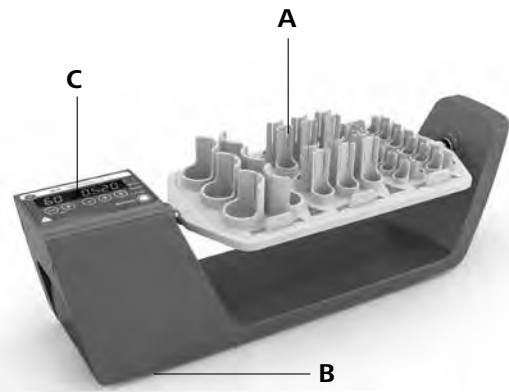

Pos.	Bezeichnung	(DE)
A	Drehscheibe	
B	Gerätefuß	
C	LED Display	
D	LED Timer h:min	
E	LED Timer min:sec	
F	LED Counter	
G	LED Timer	
H	Taste Start/Stop	
I	Taste Timer	
J	Tasten Einstellung Timer	
K	Tasten Einstellung Drehzahl	
L	Taste Power	
M	LED Power (<i>nur basic</i>)	
N	Anschluss Steckernetzteil	

Item	Designation	(EN)
A	Shaking table	
B	Device base	
C	Display LED	
D	Timer h:min LED	
E	Timer min:sec LED	
F	Counter LED	
G	Timer LED	
H	Start/Stop button	
I	Timer button	
J	Timer setting button	
K	Speed setting button	
L	Power button	
M	Power LED (<i>only basic</i>)	
N	AC adapter connection	

Pos.	Désignation	(FR)
A	Disque rotatif	
B	Pied de l'appareil	
C	Écran LED	
D	Minuteur LED h:min	
E	Minuteur LED min:sec	
F	Compteur LED	
G	Minuteur LED	
H	Touche Start / Stop	
I	Touche minuteur	
J	Touche de réglage minuteur	
K	Touche de réglage du régime	
L	Touche Power	
M	LED Power (<i>uniquement basic</i>)	
N	Fiche de branchement bloc secteur	

Contents

	Page
EU Declaration of conformity	10
Explication of warning symbols	10
Warranty	10
Safety instructions	11
Unpacking	11
Correct use	12
Useful information	12
Commissioning	12
Accessories	15
Maintenance and cleaning	15
Error codes	15
Technical data	1

EU Declaration of conformity

We declare under our sole responsibility that this product corresponds to the regulations 2014/35/EU, 2006/42/EC, 2014/30/EU and 2011/65/EU and conforms with the standards or standardized documents: EN 61010-1, EN 61010-2-051, EN 61326-1, EN 60529 and EN ISO 12100.

A copy of the complete EU Declaration of Conformity can be requested.

Explication of warning symbols



General hazard



Crush hazard!

Warranty

In accordance with **IKA** warranty conditions, the warranty period is 24 months. For claims under the warranty please contact your local dealer. You may also send the machine direct to our factory, enclosing the delivery invoice and giving reasons for the claim. You will be liable for freight costs.

The warranty does not cover worn out parts, nor does it apply to faults resulting from improper use, insufficient care or maintenance not carried out in accordance with the instructions in this operating manual.

Safety instructions

For your protection



- **Read the operating instructions in full before starting up and follow the safety instructions.**

- Keep the operating instructions in a place where they can be accessed by everyone.
- Ensure that only trained staff work with the appliance.
- Follow the safety instructions, guidelines, occupational health and safety and accident prevention regulations.
- Wear your personal protective equipment in accordance with the hazard category of the medium to be processed. Otherwise there is a risk of:
 - splashing liquids
 - projectile parts
 - body parts, hair, clothing and jewellery getting caught.
- Set up the device in a spacious area on an even, stable, clean, non-slip, dry and fireproof surface.
- The feet of the appliance must be clean and undamaged.
- Check the appliance and accessories beforehand for damage each time you use them. Do not use damaged components.



- **Caution!** There is a crush hazard between the moving shaking table and the casing.

- Place the test tubes securely on the shaking table or on the chosen mat or rack.
- Firmly secure the accessories and test tubes in place, otherwise test tubes could be damaged or projected out.
- Position one single test tubes in the centre and several test tubes so that they are evenly spread out.
- Always load the samples evenly on the device.
- The weight of the load must not exceed 2 kg. Do not exceed the maximum permissible shaking weights.
- Do not move or transport the device when it is operating or connected to the power supply.
- Reduce the speed if
 - the medium splashes out of the test tubes because the speed is too high,
 - the appliance is not running smoothly,
 - dynamic forces start to cause the device and/or the test tubes placed on it to move around.

- The appliance is not suitable for manual operation.
- Beware of the risk of
 - flammable materials
 - glass breakage as a result of mechanical shaking power
- The appliance may heat up when in use.
- Only process media that will not react dangerously to the extra energy produced through processing. This also applies to any extra energy produced in other ways, e.g. through light irradiation.
- Process pathogenic materials only in closed vessels under a suitable extractor hood. Please contact **IKA** if you have any questions.
- Do **not** operate the appliance in explosive atmospheres, with hazardous substances or under water.
- Safe operation is only guaranteed with the accessories described in the "Accessories" chapter.
- Always disconnect the plug before fitting accessories.
- Disconnect the device from the power supply before you open the cover or adjust the inclination angle of the device shaking table.
- Do not operate the device with the cover open.
- The appliance can only be disconnected from the mains supply by pulling out the mains plug or the connector plug.
- The socket for the mains cord must be easily accessible.
- The **IKA Trayster basic** does not restart automatically when power is restored after a power outage. If the **IKA Trayster digital** is running in mode A it does not restart automatically when power is restored after a power outage.

For protection of the equipment

- The appliance may only be opened by experts.
- The voltage stated on the type plate must correspond to the mains voltage.
- Removable parts must be refitted to the appliance to prevent the infiltration of foreign objects, liquids etc..
- Protect the appliance and accessories from bumps and impacts.
- The device must only be operated with the original plug-in power supply unit.

Unpacking

- **Unpacking**
 - Please unpack the device carefully.
 - In the case of any damage a detailed report must be sent immediately (post, rail or forwarder).
- **Delivery scope**
 - **IKA Trayster basic/digital**, depending on the type that was ordered
 - AC adapter, see Fig. 1
 - Operating instructions
 - Warranty card

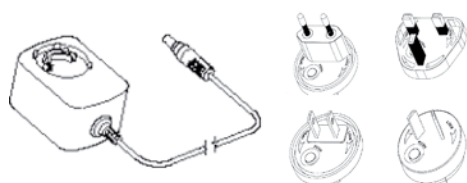

Fig. 1

Correct use

Use

For mixing and agitating liquids.

IKA Trayster basic

- Continuous operation for individual or multiple test tubes.

IKA Trayster digital

- Continuous operation for individual or multiple test tubes.

- Timer operation for individual or multiple test tubes.

Range of use

Indoor environments similar to that a laboratory of research, teaching, trade or industry.

The safety of the user cannot be guaranteed:

- If the device is operated with accessories that are not supplied or recommended by IKA.
- If the device is operated improperly or in contrary to the IKA specifications.
- If the device or the printed circuit board are modified by third parties.

Useful information

The slip coupling allows the mounting frames for the inserts to be rotated manually.

When the shaking process is switched off, either at expiry of the timer countdown or after the Start/Stop button has been pressed the device stops with the inserts always in the horizontal position.

Commissioning

- Check that the power supply matches the data on the rating plate.
- Plug the AC adapter into a standard mains socket in order to supply the device with power. See the section "Technical data" for the connection values.
- Also pay attention to the ambient conditions listed in the "Technical data".

- The **IKA Trayster basic** does not restart automatically when power is restored after a power outage. If the **IKA Trayster digital** is running in mode A it does not restart automatically when power is restored after a power outage.

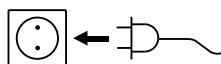

If these conditions are met the unit is ready for service when the mains plug has been plugged in.

IKA Trayster basic

The AC adapter is suitable for 100 V upto 240 V. Insert an appropriate adapter corresponding to the country, before plugging the AC adapter into the mains socket.



Switching the device on

Press the "Power" button **(L)** to switch the device on.

→ The LED **(M)** lights up green.



Starting the device

Press the "Start/Stop" button **(H)** to start the shaking process.

The device starts at the preset speed of 20 rpm.



Stopping the device

Press the "Start/Stop" button **(H)** to stop the shaking process.



Switching off the device

Press the "Power" button **(L)** to switch the device off.

→ The LED **(M)** goes out.



IKA Trayster digital

The AC adapter is suitable for 100 V upto 240 V. Insert an appropriate adapter corresponding to the country, before plugging the AC adapter into the mains socket.



Switching the device on

Press the "Power" button **(L)** to switch the device on.



The following data appear on the display in the sequence listed:

- the test image
- the software version
- the operating mode
- the values and settings last used



Speed setting

Use the "Speed setting" button **(K)** to set the speed to a value between 5 and 80 rpm in units of 1 rpm.



Timer/Counter

Select "Counter" or "Timer" **(I)**.



Timer

When "Timer" is selected, the set value counts down. Once the timed shaking cycle has been completed the device switches off automatically.

→ An acoustic signal beeps three times and the "Timer" LED **(G)** flashes red.

Counter

The counter measures the time from the start of shaking to the end.

→ The "Counter" LED **(F)** flashes red.

If the "Start/Stop" button **(H)** is pressed the shaking process stops and the elapsed time is displayed. If the counter is restarted the measurement restarts afresh.

To switch from counter to timer or vice versa, press the "Timer" button **(I)**.



Setting

Set the timer from 1 sec to 99 h 59 min using the "Plus/Minus" timer setting buttons **(J)**.

Press the "Start/Stop" button **(H)** to start the shaker.

The last timer value setting is saved and is loaded for the next shaking process.

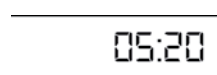

Resetting to 0

To reset the timer, press the "Timer Minus" and "Timer Plus" buttons **(J)** simultaneously.



Starting the device

Press the "Start/Stop" button **(H)** to start the shaking process.

The device starts with the desired settings.



Stopping the device

Press the "Start/Stop" button **(H)** to pause operation.



Switching off the device

Press the "Power" button **(L)** to switch the device off.



Operating modes A and B

Operating mode A

The device does not restart automatically when power is restored after a power outage.

Operating mode B

The device restarts automatically when power is restored after a power outage, using the set values, and displays the (Pr) symbol to indicate that there has been a power outage within a certain period of time.

Switching between operating modes

To switch between operating modes, switch the device off, then keep the "Start/Stop" button **(H)** depressed and press the "Power" button **(L)**.

Removal / fitting tube holders



Caution! Do not change the tube holders whilst the device is in operation!
Stop the device by pressing the "Start/Stop" button **(H)**. Do not use your hand to stop the device.
Press the "Power" button **(L)** to switch the device off.

Removal



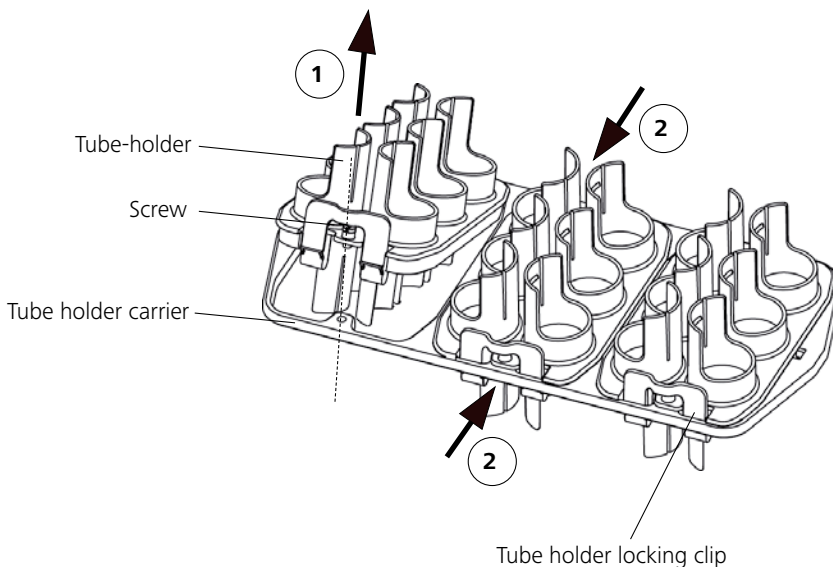

- Undo the screw **(1)**.
- Release the tube holder by pressing on the retaining hook **(2)**.
- Remove the tube holder.

Fitting

- Fitting is the reverse of removal, by inserting and pressing the tube holder into place.
A "click" confirms achievement of the correct position.



Accessories

	Designation	Description
	Set of test tubes TR 1	For 24 Eppendorf test tubes 1,5 ml, ø 10 mm
	Set of test tubes TR 2	For 24 test tubes 5 ml, ø 12 mm
	Set of test tubes TR 3	For 12 test tubes 15 ml, ø 16 mm
	Set of test tubes TR 4	For 6 test tubes 50 ml, ø 28 mm

Maintenance and cleaning

The device operates maintenance-free.

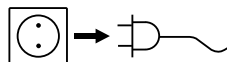

For cleaning disconnect the main plug.

- Wear protective gloves when cleaning the devices.
- Do not place electrical appliances into the cleaning agents for cleaning purposes.
- Do not allow moisture to get into the appliance when cleaning.
- Please consult with **IKA** before using any cleaning or decontamination methods, other than those recommended here.

Only clean **IKA** appliances using these **IKA** approved cleaning agents: water containing surfactant / isopropyl alcohol.

Spare parts order

When ordering spare parts, please give:

- Machine type
- Manufacturing number, see type plate
- Item and designation of the spare part, spare parts diagram and spare parts list

Repair

In case of repair the device has to be cleaned and free from any materials which may constitute a health hazard.

For this you should use the downloaded print of the "Certificate of compliance" form from the **IKA** website.

If you require servicing, return the appliance in its original packaging. Storage packaging is not sufficient. Please also use suitable transport packaging.

Error codes

IKA Trayster basic

In case of a fault, a beep is heard and the "Power" LED flashes.

Proceed as follows in such cases:

☞ Switch the device off, ☞ Perform corrective measures as described below, ☞ Perform a restart.

Error	Cause	Effect	Solution
	Motor blockage or overload	Motor off	<ul style="list-style-type: none"> - Switch the device off. - Reduce the load on the motor and check all moving parts for freedom of movement. - Then perform a restart.

IKA Trayster digital

The fault is shown by an error code in the display as following if the error occurs, e.g. Er 4.

Proceed as follows in such cases:

☞ Switch the device off, ☞ Perform corrective measures as described below, ☞ Perform a restart.

Error	Cause	Effect	Solution
Er 3	Temperature inside device is too high	Motor off	- Switch the device off. - Allow the device to cool down.
Er 4	Motor blockage or overload	Motor off	- Switch the device off. - Reduce the load on the motor and check all moving parts for freedom of movement. - Then perform a restart.

If the actions described fail to resolve the fault or another error code is displayed then take one of the following steps:

- Contact the **IKA** service department,
- Send the device for repair, including a short description of the fault.

Technical data

Power supply

Input	V	100 ... 240
	A	0,8
Output	Hz	50/60
	Vdc	24
		24W.LPS
		(Limited power source)
Protection class		2 (double insulated) <input type="checkbox"/>

Shaker

		IKA Trayster basic	IKA Trayster digital
DC	V		24
Max. device power consumption	W		24
Motor power consumption	W		16
Motor output power	W		9
Type of movement			inversion
Permissible shaken weight (incl. fixture)	kg		2
Speed min.	rpm	-	5
Speed preset definitely	rpm	20	-
Speed max.	rpm	-	80
Speed variation	%	10	5
Adjustment speed		-	1 rpm steps
Speed display		-	7-segment LED
Timer		-	yes
Timer display		-	7 Segment LED
Operating mode		continuous operation	timer and continuous operation
Adjustment timer min.	sec	-	1
Adjustment timer max.	h:min	-	99 h 59 min
Dimensions (WxDxH)	mm	460x140x180	460x140x180
Weight	kg	1.6	1.6
Perm. duration of operation	%		100
Perm. ambient temperature	°C		+ 4 ... + 50
Perm. rel. humidity	%		80
Protection acc. DIN EN 60529			IP 21
Overvoltage category			II
Protection class			II
Contamination level			2
Operation at a terrestrial altitude	m		max. 2000 above sea level

Subject to technical changes!