



KERN & Sohn GmbH

# Operating instructions

## Bench scale

### KERN FPE

Type TFPE-A

Version 2.0

2025-11

en



TFPE-A-BA-e-2520



# KERN FPE

Version 2.0 2025-11

## Operating instructions Bench scale

### Contents

<b>1</b>	<b>Technical data</b> .....	<b>4</b>
<b>2</b>	<b>Declaration of Conformity</b> .....	<b>6</b>
<b>3</b>	<b>Device overview</b> .....	<b>7</b>
3.1	Components .....	7
3.2	Operating elements .....	8
3.2.1	Keyboard overview .....	8
3.2.2	Numerical input.....	9
3.2.3	Display overview.....	9
<b>4</b>	<b>Basic information (general)</b> .....	<b>10</b>
4.1	Intended use.....	10
4.2	Improper use .....	10
4.3	Guarantee .....	10
4.4	Test equipment monitoring .....	11
<b>5</b>	<b>Basic safety instructions</b> .....	<b>11</b>
5.1	Observe the notes in the operating instructions .....	11
5.2	Staff training .....	11
<b>6</b>	<b>Transport and storage</b> .....	<b>11</b>
6.1	Control on takeover .....	11
6.2	Packaging/return transport .....	11
<b>7</b>	<b>Unpacking, installation and commissioning</b> .....	<b>12</b>
7.1	Installation site, place of use .....	12
7.2	Unpacking and checking .....	13
7.3	Assembly, installation and levelling .....	14
7.4	Mains connection.....	15
7.5	Battery operation (optional) .....	16
7.5.1	Insert battery .....	17
7.5.2	Charge battery .....	18
7.6	Initial commissioning .....	18
7.7	Adjustment .....	19
7.7.1	External adjustment.....	20

7.7.2	Linearisation .....	21
<b>8</b>	<b>Calibration .....</b>	<b>23</b>
<b>9</b>	<b>Operation .....</b>	<b>25</b>
9.1	Switch on .....	25
9.2	Switch off .....	25
9.3	Zerosetting .....	26
9.4	Taring .....	26
9.5	Simple weighing .....	27
9.6	Switching the weighing unit .....	28
9.7	Display increased resolution (x10).....	28
9.8	"Piece counting" function .....	29
9.9	"Tolerance weighing" function .....	31
<b>10</b>	<b>Menu .....</b>	<b>33</b>
10.1	Navigation in the menu .....	33
10.2	Overview of the menu .....	35
<b>11</b>	<b>Maintenance, servicing, disposal.....</b>	<b>37</b>
11.1	Cleaning .....	37
11.2	Maintenance, servicing.....	37
11.3	Waste disposal.....	37
<b>12</b>	<b>Small breakdown service .....</b>	<b>38</b>
<b>13</b>	<b>Error messages.....</b>	<b>39</b>

## 1 Technical data

<b>KERN</b>	<b>FPE 3K-4</b>	<b>FPE 6K-3</b>	<b>FPE 15K-3</b>	<b>FPE 30K-3</b>
Item number / type	TFPE 3K-4-A	TFPE 6K-3-A	TFPE 15K-3-A	TFPE 30K-3-A
Readability (d)	0.0002 kg	0.0005 kg	0.001 kg	0.002 kg
Weighing range (max)	3 kg	6 kg	15 kg	30 kg
Reproducibility	0.0002 kg	0.0005 kg	0.001 kg	0.002 kg
Linearity	± 0.0006 kg	± 0.0015 kg	± 0.003 kg	± 0.006 kg
Settling time (typical)	2 s			
Smallest part weight when counting parts under laboratory conditions*	200 mg	500 mg	1 g	2 g
Smallest part weight when counting parts under normal conditions**	2 g	5 g	10 g	20 g
Adjustment points	3 kg	6 kg	15 kg	30 kg
Recommended calibration weight, not included, (class)	3 kg (M1)	6 kg (M1)	15 kg (M1)	30 kg (M1)
Warm-up time	30 min			
Weighing units	kg, g, pcs			
Air humidity	max. 85% rel. (non-condensing)			
Permissible ambient temperature	-10 °C ... + 40 °C			
Input voltage device	5 V, 1 A			
Input voltage power supply unit	100 V - 240V; 50 / 60Hz			
Battery operation (option)	Operating time 500 h (backlight off) Operating time 400 h (backlight on) Charging time approx. 4 h			
Housing dimensions	288 x 233 x 102 (W x D x H) [mm]			
Weighing plate, stainless steel	190 x 230 (W x D) [mm]			
Net weight (kg)	1.7 kg			

<b>KERN</b>	<b>FPE 3K-3M</b>	<b>FPE 6K-3M</b>	<b>FPE 15K-3M</b>	<b>FPE 30K-2M</b>
Item number / type	TFPE 3K-3M-A	TFPE 6K-3M-A	TFPE 15K-3M-A	TFPE 30K-2M-A
Readability (d)	0.001 kg	0.002 kg	0.005 kg	0.01 kg
Weighing range (max)	3 kg	6 kg	15 kg	30 kg
Reproducibility	0.001 kg	0.002 kg	0.005 kg	0.01 kg
Linearity	± 0.003 kg	± 0.006 kg	± 0.015 kg	± 0.03 kg
Minimum weight (min.)	0.02 kg	0.04 kg	0.1 kg	0.2 kg
Settling time (typical)	2 s			
Calibration value (e)	0.001 kg	0.002 kg	0.005 kg	0.01 kg
Calibration class	III	III	III	III
Smallest part weight when counting parts under laboratory conditions*	1 g	2 g	5 g	10 g
Smallest part weight when counting parts under normal conditions**	10 g	20 mg	50 g	100 g
Warm-up time	10 min			
Weighing units	kg, g			
Air humidity	max. 85% rel. (non-condensing)			
Permissible ambient temperature	-10 °C ... + 40 °C			
Input voltage device	5 V, 1 A			
Input voltage power supply unit	100 V - 240V; 50 / 60Hz			
Battery operation (option)	Operating time 500 h (backlight off) Operating time 400 h (backlight on) Charging time approx. 4 h			
Housing dimensions	288 x 233 x 102 (W x D x H) [mm]			
Weighing plate, stainless steel	190 x 230 x 20 (W x D x H) [mm]			
Net weight (kg)	1.7 kg			

**\* Smallest part weight for piece counting - under laboratory conditions:**

- There are ideal environmental conditions for high-resolution counting
- The counting parts have no dispersion

**\*\* Smallest part weight for piece counting - under normal conditions:**

- Unsettled ambient conditions prevail (wind draught, vibrations)
- The counting parts scatter

## **2 Declaration of Conformity**

You can find the current EC/EU Declaration of Conformity online.

### 3 Device overview

#### 3.1 Components





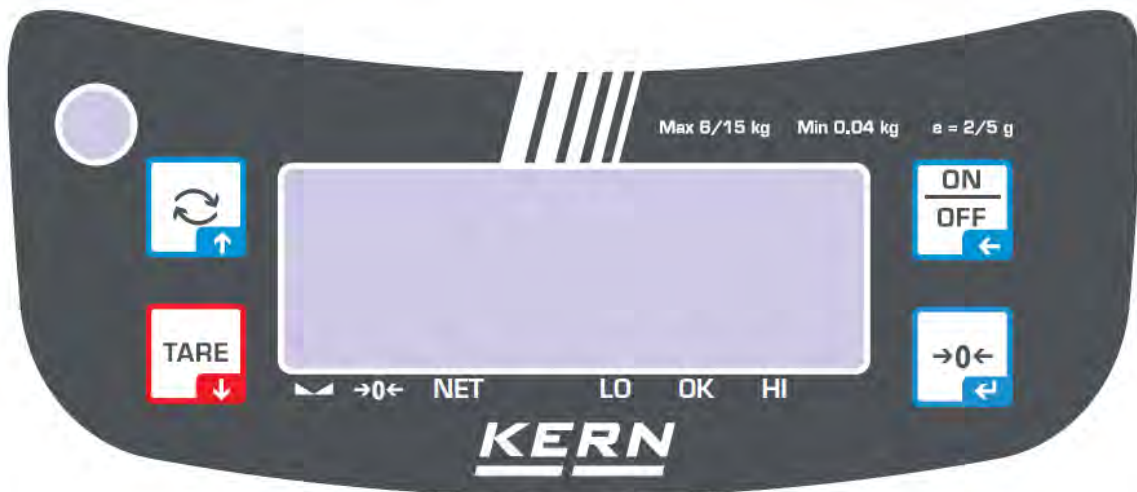

Pos.	Designation	Pos.	Designation
1	Weighing plate	6	Mains connection
2	Keyboard	7	Battery compartment
3	Display		
4	Bubble level		
5	Foot screws		



## 3.2 Operating elements





### 3.2.1 Keyboard overview

Button	Designation	Function in operating mode	Function in the menu
	[ON/OFF]	<ul style="list-style-type: none"> <li>Switch on / Switch off</li> </ul>	<ul style="list-style-type: none"> <li>Navigation button ←</li> <li>Menu level back</li> </ul>
	[ZERO]	<ul style="list-style-type: none"> <li>Zeros</li> </ul>	<ul style="list-style-type: none"> <li>Confirm menu item</li> </ul>
	[TARE]	<ul style="list-style-type: none"> <li>Taring</li> </ul>	<ul style="list-style-type: none"> <li>Navigation button ↓</li> <li>Select menu item</li> </ul>
	[CHANGE]	<ul style="list-style-type: none"> <li>Switch the displayed weighing unit</li> </ul>	<ul style="list-style-type: none"> <li>Navigation button ↑</li> </ul>

### 3.2.2 Numerical input

Button	Designation	Description
	[ZERO]	Select digit
		Confirm entry (press button repeatedly for each digit)
	[TARE]	Decrease flashing digit
	[CHANGE]	Increase flashing digit

### 3.2.3 Display overview

Display	Description
	Battery charge level indicator
→0←	Zero display
	Stability indicator
NET	Display net weight value
LO	Tolerance limit undercut
OK	Value within the tolerance limits
HI	Tolerance limit exceeded
kg / g	Weighing unit

## 4 Basic information (general)

### 4.1 Intended use

The scales you have purchased are used to determine the weight of goods to be weighed. It is intended for use as a "non-automatic scale", i.e. the sample is placed manually, carefully and centred on the weighing plate. Once a stable weight value has been reached, the weight value can be read off.

### 4.2 Improper use

- Our scales are non-automatic scales and are not intended for use in dynamic weighing processes. However, the scales can also be used for dynamic weighing processes after checking the individual area of application and, in particular, the accuracy requirements of the application.
- Do not leave a permanent load on the weighing plate. This can damage the measuring mechanism.
- Avoid shocks and overloading the scales above the specified maximum load (Max), minus any tare load already present. This could damage the scales.
- Never operate the scales in potentially explosive atmospheres. The standard version is not explosion-proof.
- The scale must not be modified in any way. This can lead to incorrect weighing results, safety-related defects and the destruction of the scale.
- The scale may only be used in accordance with the specifications described. Deviating areas of use/application must be approved in writing by KERN.

### 4.3 Guarantee

Warranty expires with

- Non-compliance with our specifications in the operating instructions
- Use outside the described applications
- Modifying or opening the device
- Mechanical damage and damage caused by media, liquids  
Natural wear and tear
- Improper set-up or electrical installation
- Overload of the measuring unit

#### 4.4 Test equipment monitoring

As part of quality assurance, the metrological properties of the scales and any test weights must be checked at regular intervals. The responsible user must define a suitable interval as well as the type and scope of this check. Information regarding the monitoring of test equipment for balances and the test weights required for this is available on the KERN homepage ([www.kern-sohn.com](http://www.kern-sohn.com)). In its accredited calibration laboratory, KERN can calibrate test weights and scales quickly and cost-effectively (traceability to the national standard).

### 5 Basic safety instructions

#### 5.1 Observe the notes in the operating instructions



⇒ Read the operating instructions carefully before installation and commissioning, even if you already have experience with KERN scales.

#### 5.2 Staff training

The appliance may only be operated and maintained by trained personnel.

### 6 Transport and storage

#### 6.1 Control on takeover

Please check the packaging immediately upon receipt and the appliance for any visible external damage when unpacking.

#### 6.2 Packaging/return transport



- ⇒ Keep all parts in the original packaging for any necessary return transport.
- ⇒ Only the original packaging is to be used for return transport.
- ⇒ Disconnect all connected cables and loose/moving parts before despatch.
- ⇒ Refit any transport locks provided.
- ⇒ Secure all parts, e.g. draft shield, weighing plate, power supply unit, etc. against slipping and damage.

## 7 Unpacking, installation and commissioning

### 7.1 Installation site, place of use

The scales are designed to achieve reliable weighing results under normal operating conditions.

You can work accurately and quickly if you choose the right location for your scales.

#### **Observe the following at the installation site:**

- Place the scales on a stable, level surface.
- Avoid extreme heat and temperature fluctuations, e.g. by placing the appliance next to a radiator or in direct sunlight.
- Protect the scales from direct draughts through open windows and doors.
- Avoid vibrations during weighing.
- Protect the scales from high humidity, vapours and dust.
- Do not expose the appliance to high humidity for long periods of time. Unauthorised condensation (condensation of humidity on the appliance) can occur if a cold appliance is brought into a much warmer environment. In this case, acclimatise the appliance disconnected from the mains for approx. 2 hours at room temperature.
- Avoid static charging of items to be weighed and weighing containers.
- Do not operate in potentially explosive atmospheres or in areas at risk of explosion due to gases, vapours, mists or dusts!
- Chemicals (e.g. liquids or gases) that could attack and damage the inside or outside of the scales must be kept away.
- If electromagnetic fields or static charges occur (e.g. when weighing / counting plastic parts) or if the power supply is unstable, large display deviations (incorrect weighing results and damage to the scales) are possible. The location must then be changed or the source of interference eliminated

## **7.2 Unpacking and checking**

Remove the appliance and accessories from the packaging, remove the packaging material and set up at the designated workstation. Check that all parts included in the scope of delivery are present and undamaged.

### **Scope of delivery / standard accessories:**

- Scale
- Weighing plate carrier with hexagonal cross recess spanner
- Weighing plate
- Mains cable
- Battery
- Operating instructions

### 7.3 Assembly, installation and levelling

#### Install the weighing plate:

1. Insert the weighing plate support (A) with the pins (Z) into the holes (Z) provided.
2. Fasten the weighing plate support with the 2 screws (S). You will find a suitable hexagon spanner on the top of the weighing plate support.

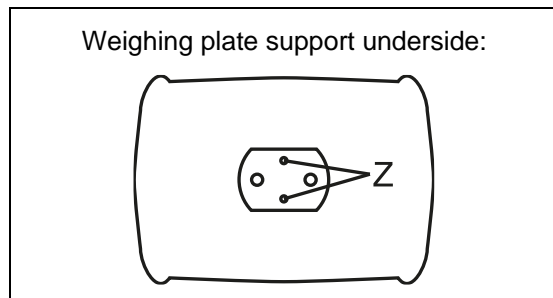
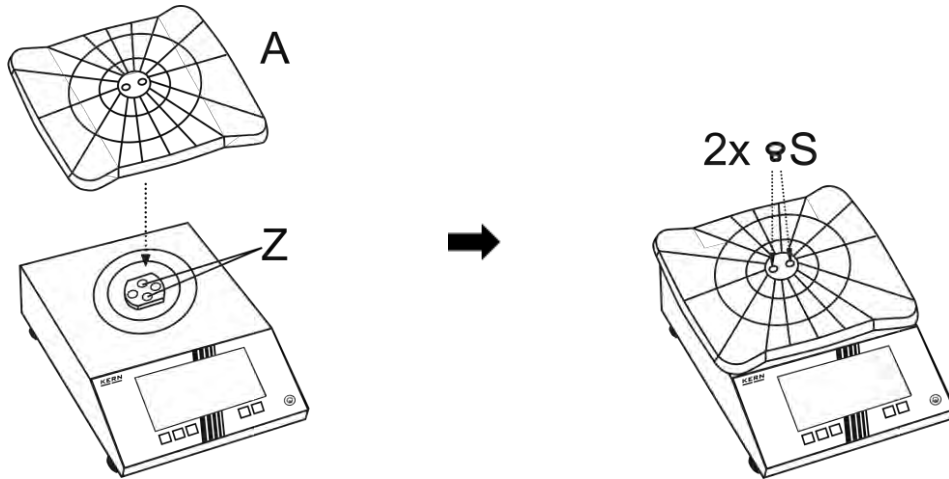

3. Place the weighing plate (B) on the weighing plate support.

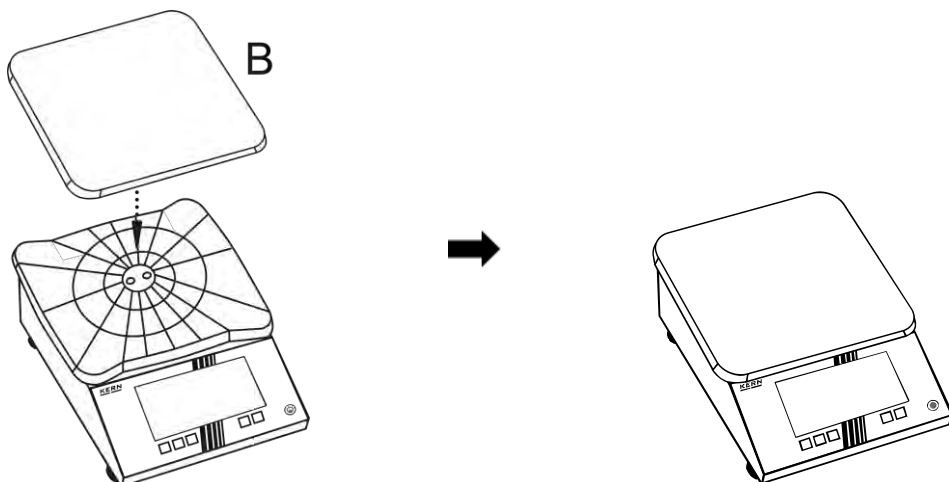

## Levelling:

1. Set up the scales at the place of use and ensure that the scales are level.
2. Level the scales with the foot screws (1) until the air bubble in the spirit level is in the prescribed circle (2).
3. Check levelling regularly.

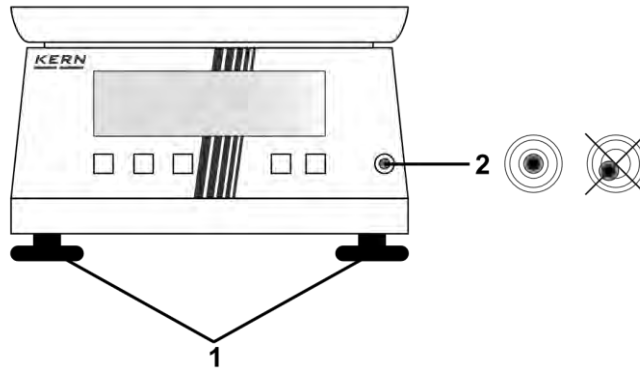

## 7.4 Mains connection



Select the country-specific mains plug and plug it into the plug it in.



Check that the voltage input of the scale is set correctly. The scale may only be connected to the mains if the information on the scale (sticker) and the local mains voltage are identical.

Only use original KERN power supply units. The use of other makes requires the approval of KERN.





### Important:

- Check the mains cable for damage before commissioning.
- Ensure that the power supply unit does not come into contact with liquids.
- The mains plug must be accessible at all times.

## Connect the scales to the power supply:

1. Plug the USB cable into a mains plug with a USB-A connection (observe the current specifications in the technical data) and insert the hollow plug into the scale.
2. Insert the mains plug into the socket

## 7.5 Battery operation (optional)

<b>ATTENTION</b>	⇒ The battery and charger are matched to each other. Only use the mains adapter supplied.
	⇒ The battery can only be replaced by the same type or by a type recommended by the manufacturer.
	⇒ The battery is not protected against all environmental influences. If the battery is exposed to certain environmental influences, the battery may catch fire or explode. People can be seriously injured or property damage can occur.
	⇒ Protect the battery from fire and heat. ⇒ Do not bring the battery into contact with liquids, chemicals or salts. ⇒ Do not expose the battery to high pressure or microwaves. ⇒ The batteries and charger must not be modified or manipulated under any circumstances. ⇒ Do not use a defective, damaged or deformed battery. ⇒ Do not connect or short-circuit the electrical contacts of the battery with metal objects. ⇒ Liquid may escape from a damaged battery. If the liquid comes into contact with the skin or eyes, the skin and eyes may become irritated. ⇒ Observe the correct polarity when inserting or replacing the batteries (see information in the battery compartment) ⇒ Battery operation is overridden when the mains adapter is connected. When weighing with mains operation > 48 hours, the batteries must be removed! (risk of overheating). ⇒ If the battery develops odours, becomes hot, discoloured or deformed, it must be disconnected immediately from the power supply and, if possible, from the scales.

### 7.5.1 Insert battery

1. Remove the weighing plate and take the hexagonal cross-head spanner out of the weighing plate carrier
2. Turn the scale over carefully

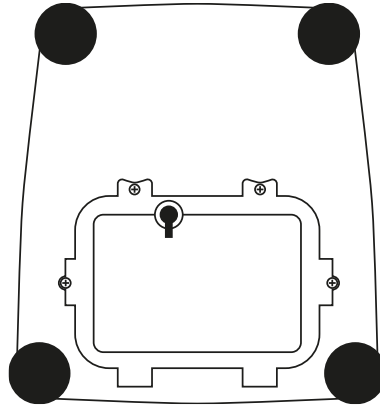

3. Open and remove the cover on the underside using the tool supplied

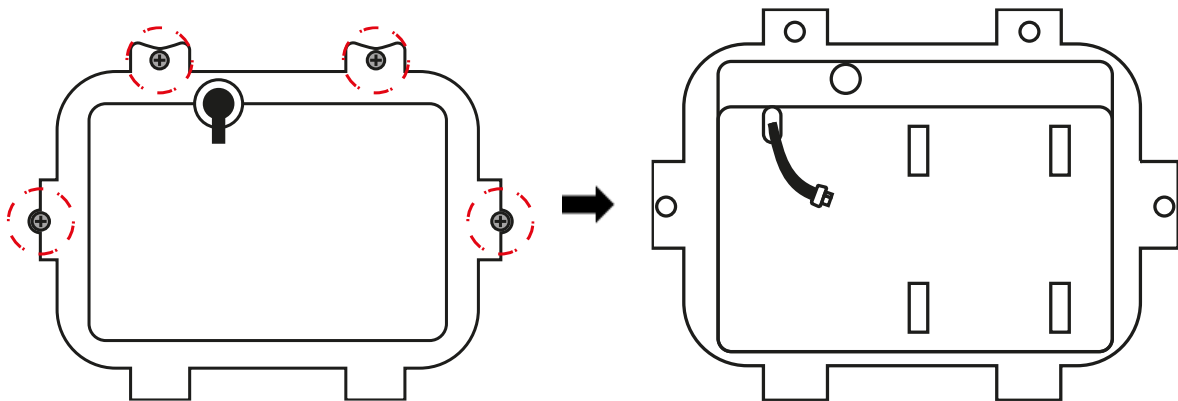

4. Insert the battery plug into the battery
5. Insert the battery into the compartment and slide it to the side until it clicks into place

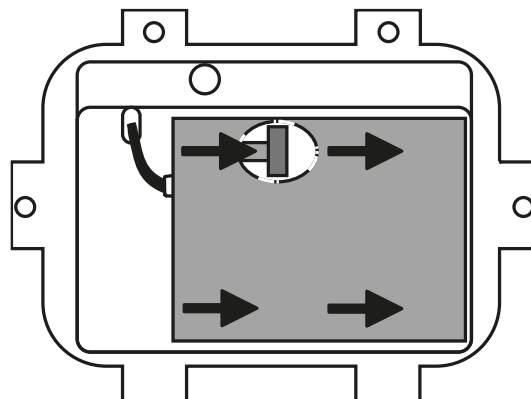

6. Reattach the cover

## 7.5.2 Charge battery

**The battery pack is charged using the mains cable supplied.**

The battery pack should be charged via the mains cable for at least 7.5 hours before first use.

To protect the battery, the automatic switch-off function can be activated in the menu (see section ).10.2

The capacity of the battery is visible in the display. Plug in the mains cable as soon as possible to charge the battery.



The battery symbol informs you about the capacity of the battery.

Symbol	Meaning
	Battery empty → Battery must be recharged
	Battery almost empty
	Battery fully charged

## 7.6 Initial commissioning

In order to obtain accurate weighing results with electronic scales, the scale must have reached its operating temperature (see warm-up time, chapter 1). The scale must be connected to the power supply (mains connection, rechargeable battery or battery) for this warm-up time.

The accuracy of the scale depends on the local gravitational acceleration.

It is essential to follow the instructions in the Adjustment chapter.

## 7.7 Adjustment

As the value of the acceleration due to gravity is not the same at every location on earth, each scale must be adjusted to the prevailing acceleration due to gravity at the installation site in accordance with the underlying physical weighing principle (only if the scale has not already been adjusted to the installation site at the factory). This adjustment process must be carried out when the scale is first put into operation, after each change of location and in the event of fluctuations in the ambient temperature. In order to obtain accurate measured values, it is also advisable to periodically adjust the scale during weighing operation.

- i** • If the value of the calibration weight is fixed in the menu of your scales, you must use such a weight for calibration.
- The accuracy of the calibration weight must correspond approximately to the readability [**d**] of the scale, or better.  
You can find information on test weights on the Internet at: <http://www.kern-sohn.com>
- Ensure stable ambient conditions. A warm-up time (see section 1) is required for stabilisation.
- Ensure that there are no objects on the weighing plate.
- Avoid vibrations and air currents.
- Only carry out adjustment with the standard weighing plate in place.
- Make sure that the correct gravitational constant for your region is set in the menu under **<F7GrA>** (see section 10.2).

The adjustment is blocked for scales with type approval.

To cancel the access lock, the sealing mark must be destroyed and the adjustment switch actuated. For the position of the adjustment switch, see chapter 8.

- **Caution:**  
If the seal has been destroyed, the scale must be recalibrated by an authorised body and a new seal affixed before it can be used again in legal-for-trade applications.

## 7.7.1 External adjustment

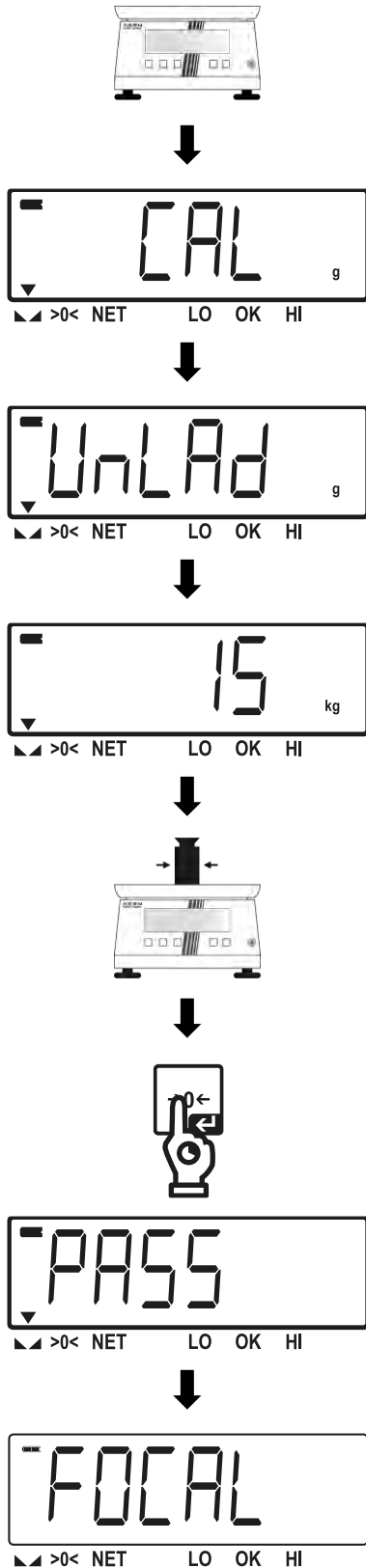

⇒ Unload the scale

⇒ Open menu (see section )10.1

⇒ **<FOCAL>** → Select **<CAL>**

⇒ Display changes to **<UNLAD>** and to the display of the required calibration weight

⇒ Place the calibration weight in the centre of the weighing plate

⇒ Wait until the "Stability indicator" is displayed

⇒ Press and hold **[ZERO]** until **<PASS>** is displayed

⇒ Display switches back to the menu

⇒ Adjustment is complete

**i** If an error message appears or the adjustment is incorrect, the adjustment must be carried out again.

## 7.7.2 Linearisation

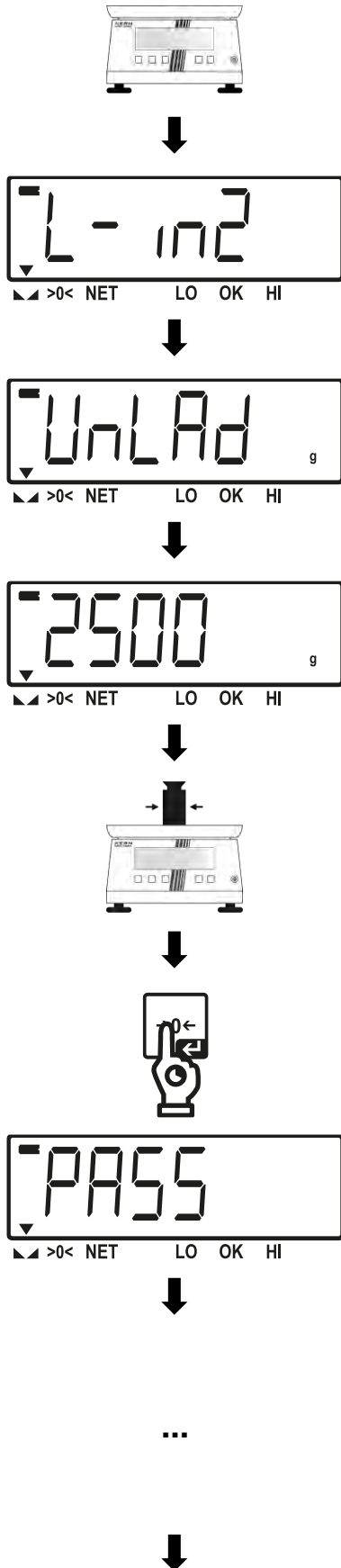

⇒ Unload the scale

⇒ Open menu (see section )10.1

⇒ **<FOCAL>** → **<L-in2>** / **<L-in3>** / **<L-in6>** select

⇒ Display changes to **<UNLAD>** and to the display of the required calibration weight

⇒ Place the calibration weight in the centre of the weighing plate

⇒ Wait until the "Stability indicator" is displayed

⇒ Press and hold **[ZERO]** until **<PASS>** is displayed

⇒ Display changes to the display of the next calibration weight

⇒ Repeat the procedure described above for all other adjustment points (either 2, 3 or 6 adjustment points)



⇒ Display changes to <UNLAD>



⇒ Unload the scale



⇒ Press and hold [ZERO] until the highest calibration weight is displayed



⇒ Place the adjustment weights as described above (in descending order of weight)

...



⇒ Display changes to <UNLAD> after the last calibration weight



⇒ Unload the scale



⇒ Keep [ZERO] pressed



⇒ Display switches back to the menu

⇒ Adjustment is complete

## 8 Calibration

### General information:

According to EU Directive 2014/31EU, scales must be calibrated if they are used as follows (legally regulated area):

- In commercial transactions, when the price of goods is determined by weighing.
- In the manufacture of medicines in pharmacies and in analyses in medical and pharmaceutical laboratories.
- For official purposes
- in the production of pre-packaging

If in doubt, please contact your local weights and measures office.

Scales in the legally regulated area (-> verified scales) must comply with the market error limits during the verification validity period - these are generally twice the verification error limits.

If this calibration validity period expires, a recalibration must be carried out. If it is necessary to adjust the scales to comply with the calibration error limits in order to pass this re-verification, this does not constitute a warranty case.

### Calibration instructions:

The scales labelled as legal for trade in the technical data have EU type approval. If the scales are used in the legal-for-trade area as described above, they must be calibrated and regularly recalibrated.

The recalibration of a scale is carried out in accordance with the respective legal regulations of the countries. The verification period in Germany, for example, is usually 2 years for scales.

The legal regulations of the country of use must be observed!



#### **The verification of the scales is invalid without the seal marks.**

In the case of scales with type approval, the attached seal marks indicate that the scales may only be opened and serviced by trained and authorised specialists. Destroyed seal marks invalidate the verification validity. The national laws and regulations must be observed. Recalibration is required in Germany.

**Position of seal marks:**

The sealing point (A) is located under the battery compartment cover.

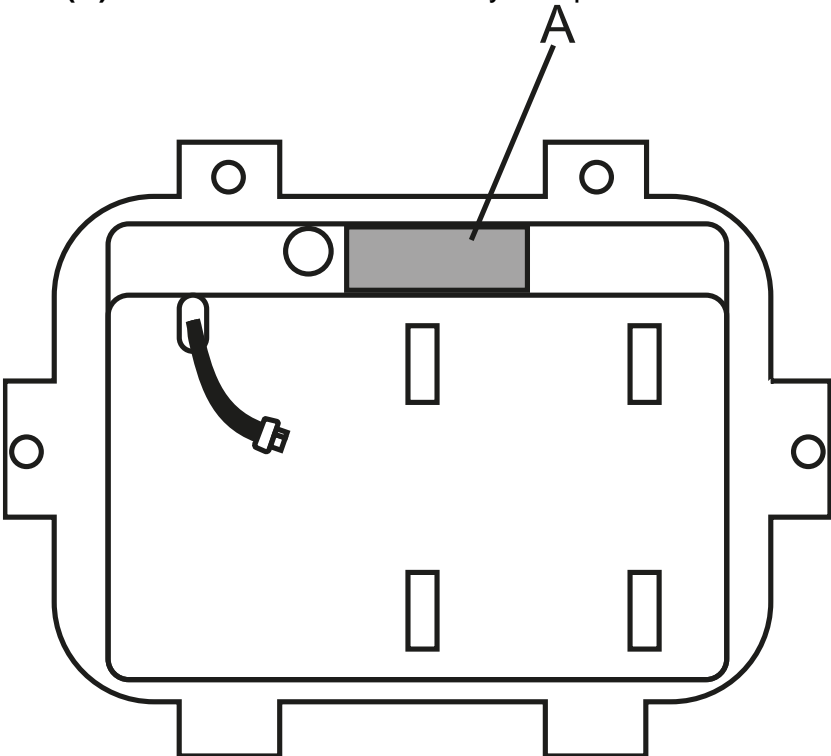

## 9 Operation

### 9.1 Switch on

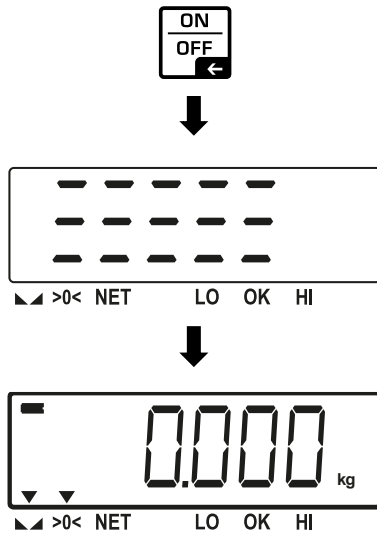

⇒ Press **[ON/OFF]**.

⇒ Display lights up

⇒ Scale is ready for operation



With calibrated scales, the software version of the calibration can be displayed with **[TARE]** at system startup.

### 9.2 Switch off

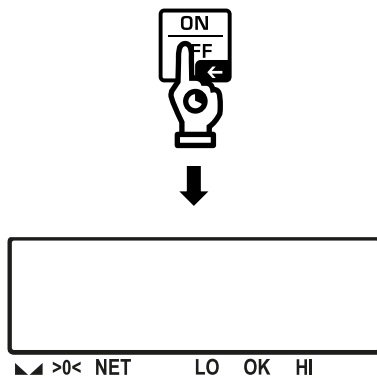

⇒ Keep **[ON/OFF]** pressed

⇒ Display switches off

⇒ Scale is switched off

### 9.3 Zeroinetting

To achieve optimum weighing results, zero the scales before weighing.

Zeroing is only possible in the range  $\pm 2\%$  max.

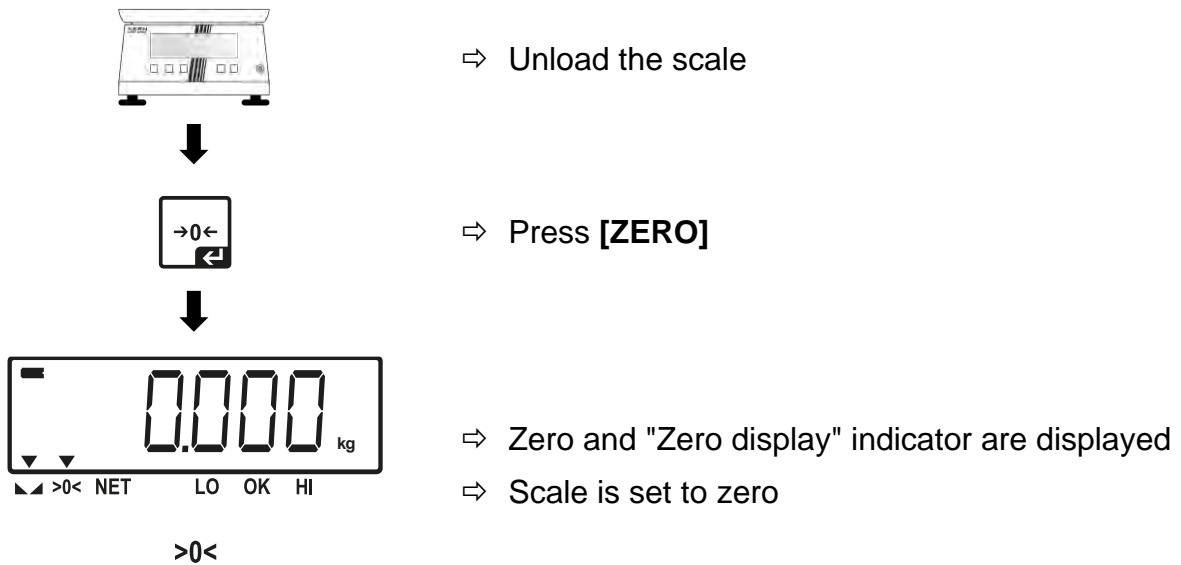

### 9.4 Taring

Taring:

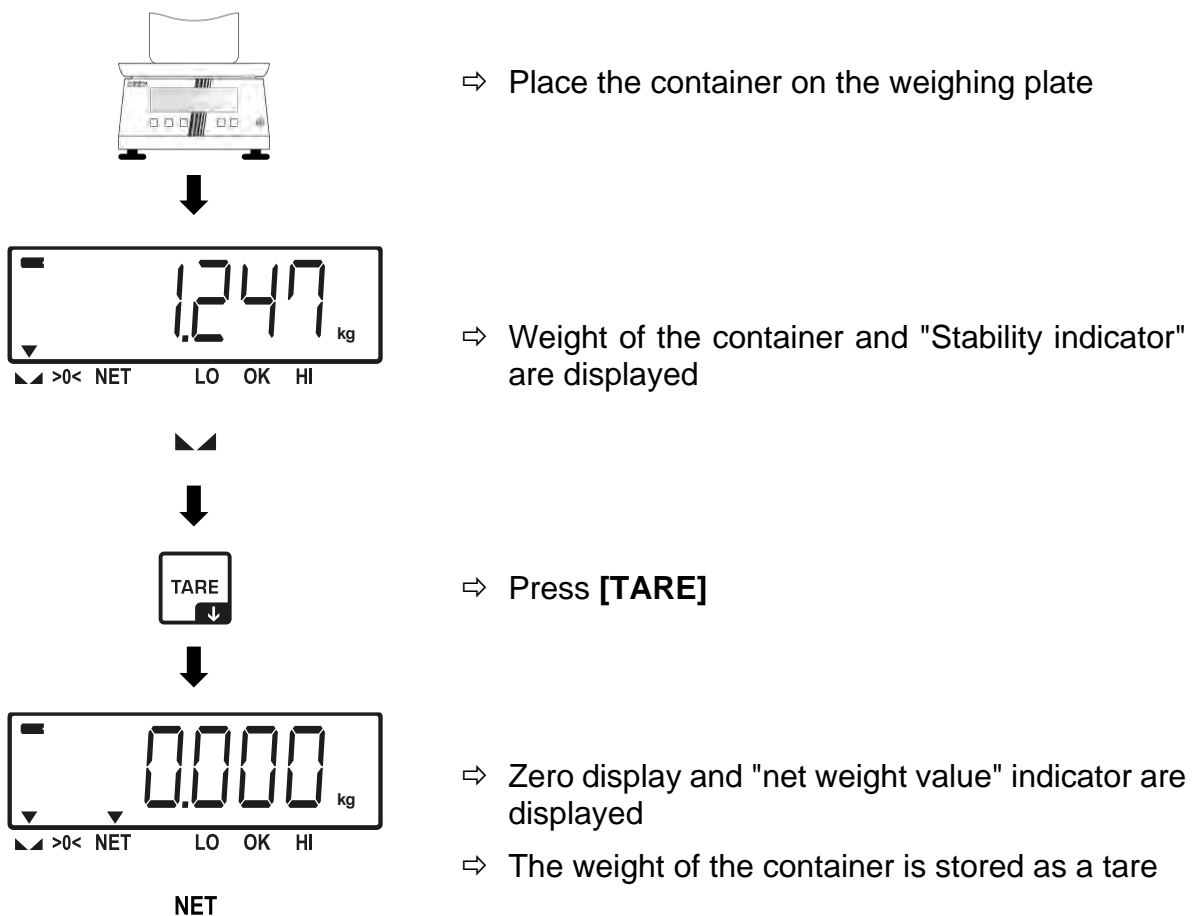

## Weighing with tare:

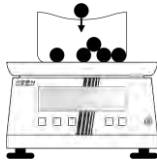

⇒ Fill the weighing sample into the container

⇒ Weight value and "Stability indicator" indicator are displayed

⇒ The weighing result can be read off



- When the scales are unloaded, the stored tare value is displayed with a negative sign.
- To delete the stored tare value, release the load on the weighing plate and press **[TARE]**.
- The taring process can be repeated any number of times, for example when weighing in several components to form a mixture (additional weighing). The limit is reached when the tare range is fully utilised. For scales without type approval, this function can be activated or deactivated (see Multi-Tare **<FC tArE>** in chapter 10.2).

## 9.5 Simple weighing



⇒ Check zero display and zero with **[ZERO]** if necessary

⇒ Place the sample on the weighing pan

⇒ Weight value and "Stability indicator" indicator are displayed

⇒ The weighing result can be read off



### Overload warning

Avoid overloading the appliance beyond the specified maximum load (Max), minus any existing tare load.

This could damage the appliance.

Exceeding the maximum load is indicated by **<--oL-->**. Unload the scale or reduce the preload.

## 9.6 Switching the weighing unit

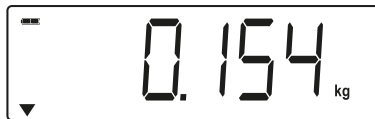

>0< NET LO OK HI



⇒ Press **[CHANGE]** to switch between the weighing units



>0< NET LO OK HI

## 9.7 Display increased resolution (x10)



>0< NET LO OK HI



⇒ In simple weighing mode, press **[CHANGE]** and **[TARE]** simultaneously



>0< NET LO OK HI

⇒ Display shows the weight with a resolution of  $d = 0.1 e$  for 5 seconds

## 9.8 "Piece counting" function

Before the scale can count parts, it must know the average piece weight, the so-called reference. To do this, a certain number of the parts to be counted must be placed on the scale. The scale determines the total weight and divides it by the number of parts, the so-called reference piece count. The count is then carried out on the basis of the calculated average piece weight.

- i** • The higher the reference quantity, the greater the counting accuracy.
- The reference must be set particularly high for small or very different parts.
- For minimum counting weight see table "Technical data"

### Perform piece counting:

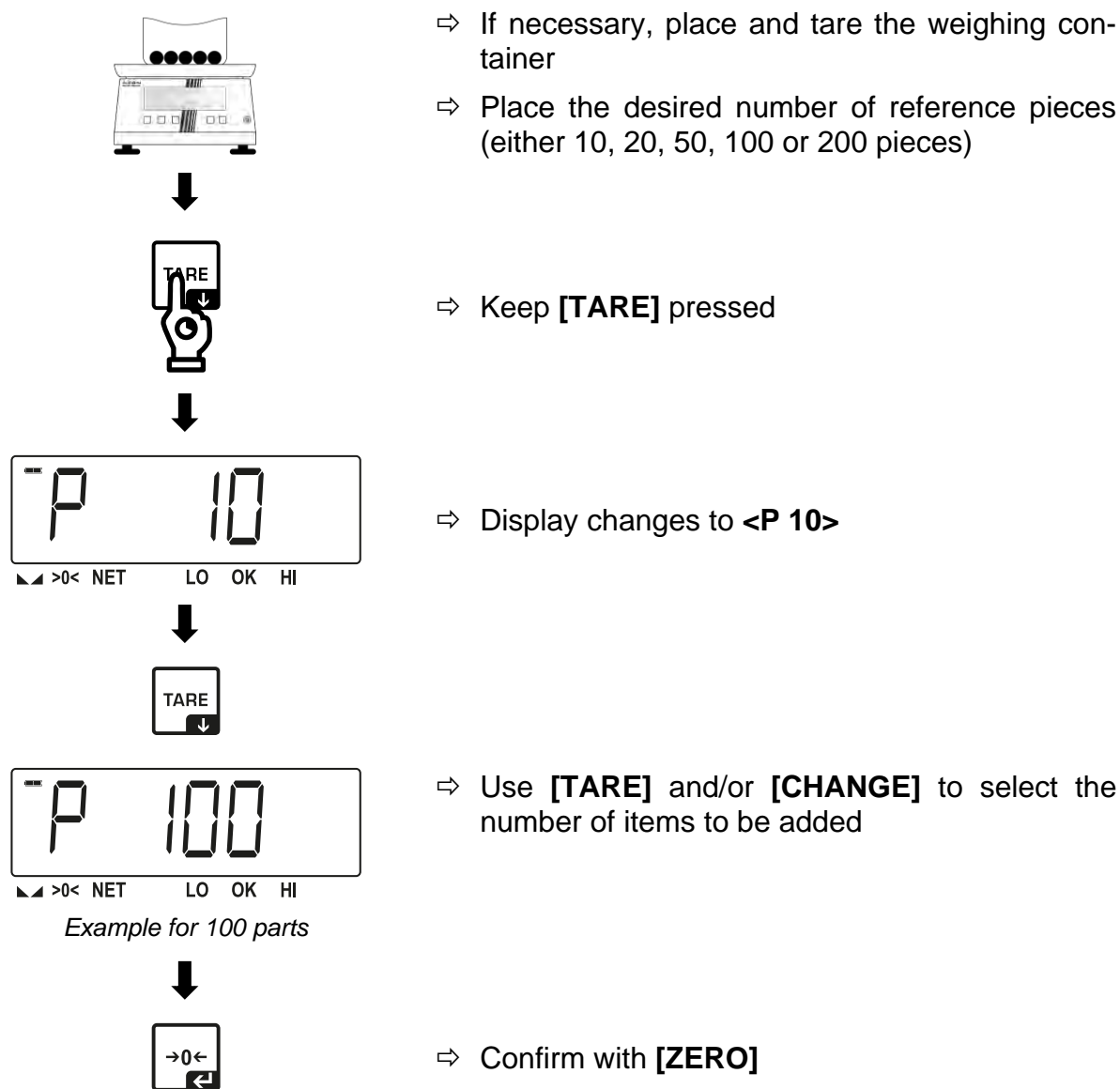

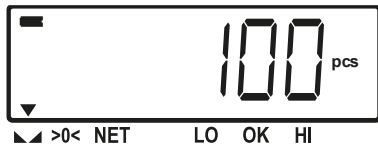

⇒ Reference quantity is saved

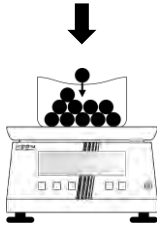

⇒ Weigh in additional parts

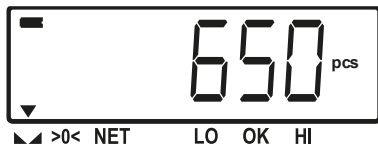

⇒ Quantity can be read off

#### Exit piece counting mode:



⇒ Hold down **[CHANGE]** (alternatively: briefly press the **[ON/OFF]** button)

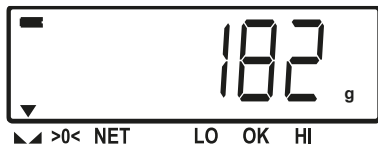

⇒ Scale returns to weighing mode

## 9.9 "Tolerance weighing" function

Set limit values:

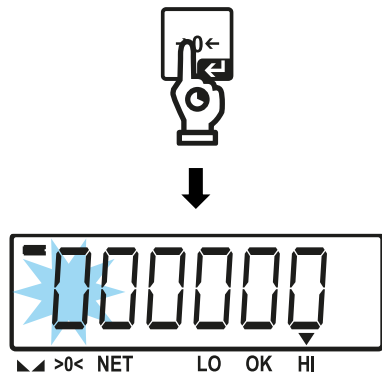

- ⇒ If necessary, place and tare the weighing container
- ⇒ Keep **[ZERO]** pressed

⇒ Display changes to **<000000>** (upper limit)

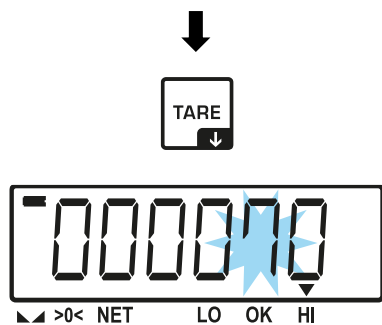

⇒ Enter the upper limit with **[TARE]**, use **[CHANGE]** to advance the flashing digit

*Example for 70 parts*



- ⇒ Confirm with **[ZERO]**
- ⇒ Upper limit is saved

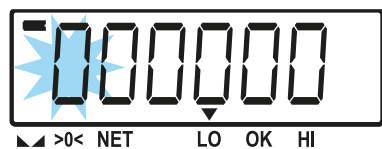

- ⇒ Display changes to the entry of the lower limit
- ⇒ Enter lower limit as above and confirm

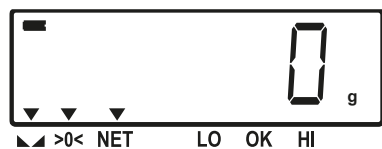

⇒ Scale switches to weighing mode

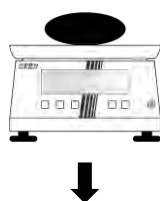

- ⇒ Check zero display and zero with **[ZERO]** if necessary
- ⇒ Place the sample on the weighing pan

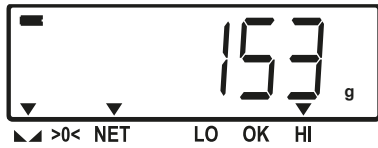

*Example for HI*

⇒ Weighing result can be read off

Example: Weighing value has exceeded the upper tolerance limit



The display of the scale changes colour depending on the evaluation of the tolerance check:

<b>Colour on the display</b>	<b>Meaning</b>
green	Weighing value within the tolerance limits
orange	Lower limit undercut
red	Upper limit exceeded

## 10 Menu

### 10.1 Navigation in the menu

Call up menu:

**Variant 1 - Open menu at system start:**



⇒ Scale is switched off

▾ ▸ >0< NET LO OK HI



⇒ Switch on the scale and press **[CHANGE]** immediately after the software version is displayed



⇒ Display changes to <F0 CAL>

▾ ▸ >0< NET LO OK HI

**Variant 2 - Open menu in weighing mode:**



⇒ Scale is in weighing mode

▾ ▸ >0< NET LO OK HI







⇒ Keep **[CHANGE]** pressed



⇒ Display changes to <F0 CAL>

▾ ▸ >0< NET LO OK HI

### Select and set parameters:

Button	Function
	<ul style="list-style-type: none"><li>• Menu level back</li></ul>
	<ul style="list-style-type: none"><li>• Confirm selection</li></ul>
	<ul style="list-style-type: none"><li>• Navigate down menu</li></ul>
	<ul style="list-style-type: none"><li>• Navigate up menu</li><li>• In the first menu level: Exit menu (long press)</li></ul>

## 10.2 Overview of the menu



- Default settings are marked with an \*.
- Menu items marked with \*!\* are blocked on models with calibration capability.

Level 1	Level 2	Description	Chapter	
<i>F0 CAL</i>		Adjustment	<b>7.7</b>	
	<i>CAL</i>	External adjustment	<b>7.7.1</b>	*!*
	<i>L-in6</i>	Linearisation (2 points, 3 points, 6 points)	<b>7.7.2</b>	
<i>F1 Unit</i>		Weighing units	-	
	<i>KG</i>	kg	-	
	<i>G</i>	g	-	
<i>F2 BL</i>		Backlighting	-	
	<i>BL on</i>	Backlighting on	-	
	<i>BL off</i>	Backlighting off	-	
	<i>BL AU1</i>	Backlight brightness: low	-	
	<i>BL AU2</i>	Backlight brightness: medium	-	
	<i>BL AU3</i>	Backlight brightness: bright	-	
<i>F3 AoF</i>		Automatic switch-off function	-	
	<i>off*</i>	Automatic switch-off function deactivated	-	
	<i>oF 3</i>	Switch off after 3 min	-	
	<i>oF 10</i>	Switch off after 10 min	-	
	<i>oF 15</i>	Switch off after 15 min	-	
	<i>oF 30</i>	Switch off after 30 min	-	
<i>F4 inP</i>		Internal value of the AD converter	-	
<i>F5 SPd</i>		Speed of the AD converter	-	
	<i>Loū</i>	Low	-	
	<i>n id*</i>	Medium	-	
	<i>HiGH</i>	High	-	

Level 1	Level 2	Description	Chapter	
<i>FB RES</i>		Resolution	-	
	<i>3000</i>	3000	-	
	<i>6000</i>	6000	-	
	<i>dUAL-1</i>	Dual	-	*!*
	<i>15000</i>	15000	-	
	<i>30000</i>	30000	-	
	<i>60000</i>	60000	-	
<i>F7 GRA</i>	<i>9.79640</i>	Gravitational constant	-	*!*
<i>FB CAP</i>		Maximum weighing capacity	-	
	<i>3KG</i>	3 kg	-	
	<i>6KG</i>	6 kg	-	*!*
	<i>15KG</i>	15 kg	-	
	<i>30KG</i>	30 kg	-	
<i>FA TARE</i>		Switching the multi-tare function on / off	-	
	<i>oFF</i>	Deactivated	-	
	<i>oN</i>	Activated	-	
<i>Fb S-UG</i>		Save or discard piece weight for piece counting	-	
	<i>oFF</i>	Discard / do not save	-	
	<i>oN</i>	Save	-	
<i>FC SLEP</i>		Sleep mode	-	
	<i>oFF</i>	Deactivated	-	
(Press ON/OFF to switch back on)	<i>oF 10</i>	Display switches off after 10 minutes with no weight change/button press	-	
	<i>oF 20</i>	Display switches off after 20 minutes with no weight change/button press	-	
	<i>oF 30</i>	Display switches off after 30 minutes with no weight change/button press	-	
<i>Fd A2n</i>				
	<i>oFF</i>			
	<i>0.5d</i>	Area for zero tracking	-	*!*
	<i>1d</i>			
	<i>2d</i>			
	<i>4d</i>			

## 11 Maintenance, servicing, disposal



Disconnect the appliance from the operating voltage before carrying out any maintenance, cleaning or repair work.

### 11.1 Cleaning

Immediately remove any spilled weighing material (e.g. loose sample residue or powder) with a brush or a handheld Hoover.

Use a mild cleaning agent such as soapy water and a soft cloth to clean the device. Then rub the device dry with a dry, soft and lint-free cloth.

#### Observe the following instructions to avoid damage:

- Do not use any aggressive cleaning agents (e.g. solvents), as this will cause reactions with the materials and damage them.
- Do not use cleaning agents containing caustic soda, acetic, hydrochloric, sulphuric or citric acid on stainless steel parts.
- Do not use metal brushes or cleaning sponges made of steel wool, as this will damage the surface.

### 11.2 Maintenance, servicing

- ⇒ The device may only be opened by trained service technicians authorised by KERN.
- ⇒ Disconnect from the mains before opening.

### 11.3 Waste disposal

The operator must dispose of the packaging and appliance in accordance with the applicable national or regional legislation at the place of use.

## 12 Small breakdown service

If there is a fault in the programme sequence, the scale should be switched off briefly and disconnected from the mains. The weighing process must then be restarted from the beginning.

### Malfunction

### Possible cause

The weight display does not light up.

- The scale is not switched on.
- The connection to the mains is interrupted (mains cable not plugged in/defective).
- The mains voltage has failed.
- The capacity of the battery is exhausted.

The weight display changes continuously

- Draught/air movement
- Vibrations of the table/floor
- The weighing plate is in contact with foreign objects.
- Electromagnetic fields/static charging (choose a different installation location/switch off the interfering device if possible)

The weighing result is obviously wrong

- The scale display is not set to zero
- The adjustment is no longer correct.
- The scale is not level.
- There are strong temperature fluctuations.
- The warm-up time was not observed.
- Electromagnetic fields / static charge (choose another installation location / if possible, switch off the interfering device)

### 13 Error messages

Error message	Explanation
<i>Err 4</i>	Zero setting range exceeded
<i>Err 6</i>	A/D value undershot or exceeded
<i>Err 19</i>	Initialisation error zero
<i>--oL--</i>	Overload
<i>--UL--</i>	Underload
<i>FR , L</i>	Adjustment error
<i>bA Lo</i>	Capacity of batteries / rechargeable batteries exhausted