

KERN OZB-A5213

Version 1.0
07/2024

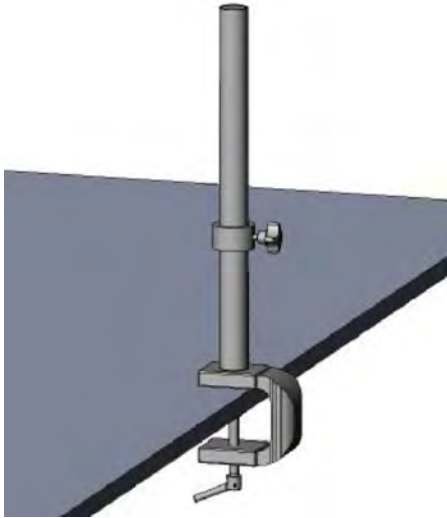

1. Fix the clamp to a flat surface.



2. Install the U3 cross arm onto the column.

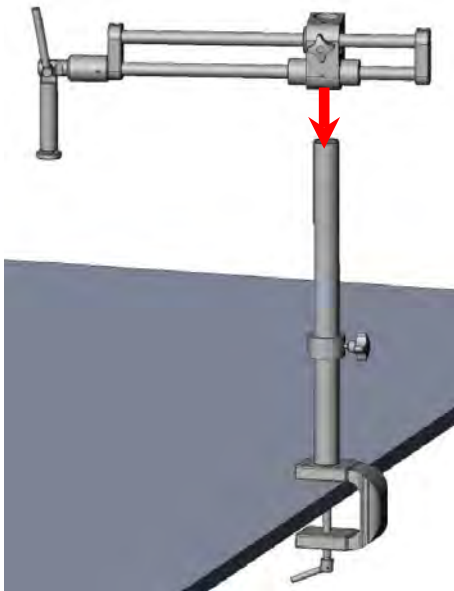

3. The finished product is as shown below after installation.

