



Frontier™ 5000 Series
Micro IVD Centrifuges
FC5513L, FC5513, FC5513R,
FC5515, FC5515R
Instruction Manual

EN

DE

FR

IT



TABLE OF CONTENTS

1	INTRODUCTION	1
1.1	Brief Product Family Description	1
1.2	Intended Use	1
1.4	Safety Signs and Warnings	1
1.5	Marking on the packaging	2
1.6	Product Label	3
1.7	Safety Precautions	4
1.7.1	Rotors and Accessories	4
1.7.2	Measures For Your Protection	4
1.7.3	Exclude The Following Environmental Influences	4
1.7.4	Measures Of Operational Safety	4
1.7.5	Danger and Precautions	5
1.7.6	Abbreviations Used In This Instruction Manual	5
2	INSTALLATION	6
2.1	Delivery Package	6
2.2	Unpacking the Centrifuge	6
2.3	Space Requirements	6
2.4	Installation	7
2.5	Safety Precautions During Operation	7
2.6	Warranty	7
3	OPERATION	8
3.1	Operating and Display Elements	8
3.2	LCD Display	9
	Refrigerated models	9
	Non-refrigerated models	9
3.3	Rotors	11
3.3.1	Overview	11
3.3.2	Installation Of Rotors	11
3.3.3	Change rotor ID / type of rotor (besides FC5513L)	12
3.3.4	Loading Angle Rotors	13
3.3.5	Loading and Overloading of The Rotors	13
3.3.6	Removing The Rotor	13
3.4	Power switch	14
3.5	Lid Control	14
3.5.1	Lid Open	14
3.5.2	Lid lock	15
3.6	Preselection	15
3.6.1	Preselection of Speed / RCF-value	15
3.6.2	Preselection of running time	16
3.6.3	Preselection of acceleration and brake intensity (deceleration)	16

3.6.4	Preselection of temperature (Only FC5513R and FC5515R)	17
3.6.5	Pre-cooling (Only FC5513R and FC5515R)	18
3.7	Radius correction	18
3.8	Program	19
3.8.1	Program storage	19
3.8.2	Recall of stored programs	20
3.8.3	Leaving program mode	21
3.9	Starting and Stopping the Centrifuge	21
3.9.1	Starting the centrifuge	21
3.9.2	Stopping the centrifuge	21
3.10	Imbalance Detection	22
4	SETTING	23
4.1	Basic Adjustments	23
4.1.1	Access to mode "Operating Data"	23
4.1.2	Temperature indication in °C or °F (only FC5513R and FC5515R)	24
4.1.3	Acoustic signal turn on /off	25
4.1.4	Volume pre-selection sound signal (only FC5515 and FC5515R)	25
4.1.5	Song selection for sound signal – end of run (only FC5515 and FC5515R)	26
4.1.6	Keyboard sound turn on /off	26
4.1.7	Call up operating data	27
5	MAINTENANCE	28
5.1	Maintenance and cleaning	28
5.1.1	General Care	28
5.1.2	Cleaning – centrifuges, rotors, accessories	28
5.1.3	Centrifuge cleaning and disinfection	28
5.1.4	Cleaning and disinfection of the rotors	29
5.1.5	Disinfection of rotors	29
5.1.6	Glass breakage	29
5.2	Service life of rotors, buckets, accessories	30
6	TROUBLESHOOTING	31
6.1	Error messages: Cause / Solution	31
6.2	Survey of possible failures and their solutions	31
6.2.1	Lid release during power failure (Emergency Lid Release)	31
6.2.2	Description of the error message system	32
6.2.3	Procedure while error 14	32
7	RECEIPT OF CENTRIFUGES TO REPAIR	33
8	TRANSPORT and STORAGE	34
8.1	Transport	34
8.2	Storage	34
9	TECHNICAL DATA	35
9.1	Specifications	35

9.1.1	Centrifuge FC5513L	35
9.1.2	Centrifuge FC5513	36
9.1.3	Centrifuge FC5513R	37
9.1.4	Centrifuge FC5515	38
9.1.5	Centrifuge FC5515R	39
9.2	Drawings and dimension	40
10	COMPLIANCE	42
11	APPENDIX	44
11.1	Table 1: Permissible net weight	45
11.2	Table 2: Max. speed and RCF-values for permissible rotors	46
11.3	Table 3: Acceleration and deceleration times	47
11.4	Table 4: Lowest temperature at max. speed in refrigerated models	49
11.5	Table 5: Error messages	50
11.6	Table 6: Radius correction and adapter specifications	51
11.7	Table 7: Table of the service life of the rotors	52
11.8	Redemption form / Decontamination certificate	53

1 INTRODUCTION

Thank you for choosing this OHAUS product.

All symbols indicate safety instructions and points to potentially dangerous situations. Please read the manual completely before using the Frontier™ Multi Centrifuges to avoid incorrect operation.

1.1 Brief Product Family Description

Frontier™ Micro IVD Centrifuges are designed to meet the diverse needs of laboratory applications like microbiology, molecular biology, biochemistry, research and others. This family includes two refrigerated models (FC5513R and FC5515R) and three non-refrigerated models (FC5513L, FC5513, and FC5515), offering high g-forces up to 21,953 x g and covers sample capacity from 0.2ml to 5ml. Thanks to excellent performance and safety features like imbalance detection and automatic imbalance switch-off, our Micro Centrifuges ensure reliable operation and protect both the instrument and the user. The refrigerated centrifuges are intended for commercial, industrial, or institutional use as defined in the safety standards for refrigeration systems according to ANSI/ASHRAE 15.

1.2 Intended Use

These centrifuges and their accessories are an in vitro diagnostic medical device within the meaning of the In Vitro Diagnostic Medical Devices Regulation (EU) 2017/746. This centrifuge is intended for the separation of mixtures of substances of different densities, in particular for the preparation and processing of samples from the human body in the context of an in vitro diagnostic application, in order to enable the intended use of the in vitro diagnostic medical device.

These centrifuges are intended exclusively for use in closed rooms under supervision and for operation by trained specialist personnel!

Only the rotors and cups and other accessories specified in the instructions for use may be used. Any other use or use beyond this is considered improper use. We are not liable for any resulting damage. The contents of the operating instructions must be observed.

1.3 Contraindication

These centrifuges and their accessories are intended exclusively for the above-mentioned purpose and must not be used to determine any measured values. After centrifugation, no components of human origin may be implanted or administered back into the body.

1.4 Safety Signs and Warnings

Safety notes are marked with signal words and warning symbols. These show safety issues and warnings. Ignoring the safety notes may lead to personal injury, damage to the instrument, malfunctions, and false results.

The degree of danger is a part of a safety note and distinguishes the possible results of non-observance from each other.

Warning Symbols

- | | |
|------------------|--|
| DANGER | Will lead to severe injuries or death if not avoided. |
| WARNING | For a hazardous situation with medium risk, possibly resulting in severe injuries or death if not avoided. |
| CAUTION | For a hazardous situation with low risk, resulting in damage to the device or the property or in loss of data, or minor or medium injuries if not avoided. |
| ATTENTION | For important information about the product. May lead to equipment damage if not avoided. |
| NOTE | For useful information about the product. |

Warning and information signs on the surface of centrifuge



General hazard



Electric shock hazard



Biohazard



Warning of flammable refrigerant R290

Warning!

Four carrier must be used at all times on four places swing out rotors or damage will occur to the centrifuge. Such damage will not be covered under the warranty.

All buckets must be used at all times on all places of the swing out rotors or damage will occur to the centrifuge. Such damage will not be covered under the product warranty.

Attention!

Check the fastening of the rotor nut before each run.

Attention! Check the fastening of the rotor nut before each run.

TAKE OFF MAINS PLUG before opening the housing or the emergency release!

Take off mains plug before opening the housing or the emergency release.



Direction of rotation - clockwise rotation for the rotor drive

Only refrigerated models with R290 refrigerant. CAUTION - Fire or Explosion Hazard. Dispose of safely in accordance with applicable state or regional regulations. Contains Flammable Refrigerants.

1.5 Marking on the packaging

	<p>Keep the packaging dry. The box must be kept out of the rain and away from moisture.</p>
	<p>This way up. Indication of upright position of the transport package.</p>
	<p>Indication that the package contains fragile good.</p>
	<p>Temperature limitation. The packaging must be transported and stored within the specified range of -25 °C to +60 °C.</p>
	<p>Humidity limitation. The packaging must be transported and stored within the specified range of 10% to 75%.</p>

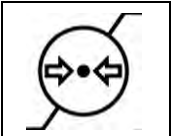

Pressure limitation. The packaging must be transported and stored within the specified range of 30 kPa to 106 kPa.

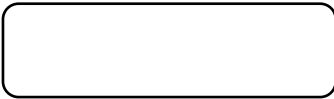

Only for US Market and refrigerated models with R290 refrigerant. CAUTION - Fire or Explosion Hazard due to Flammable Refrigerants. Handling instructions of US government regulations must be carefully followed.

1.6 Product Label

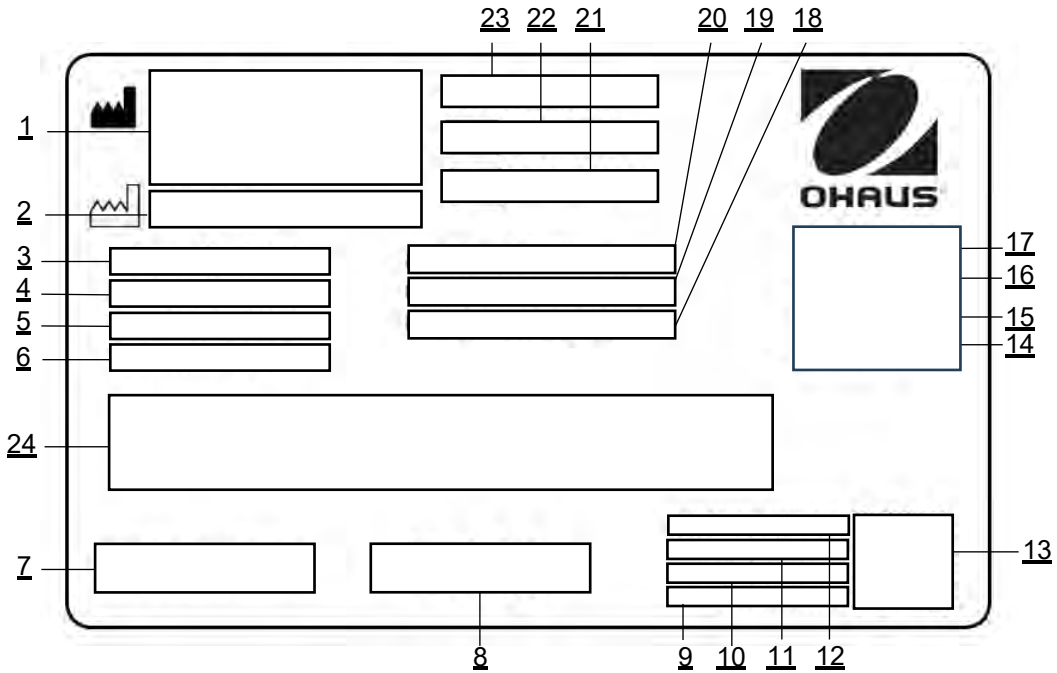

1	Legal Manufacturer	13	Data Matrix Code
2	Date of Production	14	Model-specific marks and symbols
3	Rated Voltage	15	
4	Rated Current	16	
5	Frequency	17	
6	Rated Power	18	Max. permissible Density
7	Country of Manufacture	19	Max. kinetic Energy
8	CE mark, IVD mark	20	Max. Speed
9	Product Number	21	Serial Number
10	Serial Number	22	Product Number
11	Date of Production	23	Product Name
12	Global Trade Item Number	24	Coolant Information (only refrigerated models)

1.7 Safety Precautions

1.7.1 Rotors and Accessories

Only OHAUS original rotors and accessories shall be used. Any other use or intended use is considered improper. OHAUS is not liable for damage resulting from improper use.

1.7.2 Measures For Your Protection



WARNING!

Never work in an environment subject to explosion hazards! The housing of the instrument is not gas tight. (Explosion hazard due to spark formation, corrosion caused by the ingress of gases)



WARNING!

When using chemicals and solvents, comply with the instructions of the producer and the general lab safety rules.



WARNING!

The centrifuge is not sealed. Use suitable protection measures when using the centrifuge for infectious and pathogenic samples. Follow appropriate safety precautions when handling these samples.

1.7.3 Exclude The Following Environmental Influences

- Powerful vibrations
- Direct sunlight
- Atmospheric humidity greater than 80%
- Corrosive gases present
- Temperatures below 5 °C and above 35 °C
- Powerful electric or magnetic fields



WARNING!

Electrical shock hazards exist within the housing. The housing should only be opened by authorized and qualified personnel. Remove all power connections to the unit before opening.

1.7.4 Measures Of Operational Safety

- Do not unscrew the two halves of the housing.
- Dry off any liquid spills immediately! The instrument is not watertight.
- Verify that the equipment's input voltage range and plug type are compatible with the local power supply.
- Only connect the power cord to a properly grounded power receptacle.
- Only use a power cord with a rating that exceeds the specifications on the equipment label.
- Do not position the equipment such that it is difficult to disconnect the power cord from the power receptacle.
- Make sure that the power cord does not pose a potential obstacle or tripping hazard.
- The equipment is for indoor use only. Use the equipment only in dry locations.
- Use only approved accessories.
- Operate the equipment only under ambient conditions specified in these instructions.
- Disconnect the equipment from the power supply when cleaning.
- Do not operate the equipment in hazardous or unstable environments.
- Service should only be performed by authorized personnel.
- A repair of the refrigeration circuit with R290 may only be carried out by the manufacturer.

1.7.5 Danger and Precautions



CAUTION!

This device may only be operated by a trained professional. Carefully, read the operating manual and be familiar with the functions of the device.

To protect people and the environment, the following precautions must be taken:

- The refrigerated models FC5513R and FC5515R are equipped with environment friendly refrigerant R290, which is flammable. In the event of a defect in the refrigeration circuit, the refrigerant can leak out and create an explosive mixture with the surrounding air. Ensure that there is sufficient air volume and proper ventilation at the location.
- During centrifugation, the presences of people and the setting up of hazardous materials are prohibited within 30 cm around the centrifuge according to the regulations of EN 61010-2-020.
- All micro centrifuges are not explosion-proof and must therefore not be operated in explosion-endangered areas or locations. Centrifugation of flammable, explosive, radioactive, or such substances, which chemically react with high energy, is strictly prohibited. The final decision on the risks associated with the use of such substances is the responsibility of the user of the centrifuge.
- Never spin toxic or pathogenic material without adequate safety precautions, i.e. centrifugation of buckets / tubes with missing or defective hermetic sealing is strictly prohibited. The user is obliged to perform appropriate disinfection procedures in case dangerous substances have contaminated the centrifuge and or its accessories. When centrifuging infectious substances, always pay attention to the general laboratory precautions. If necessary, contact your safety officer!
- It is prohibited to run the centrifuge with rotors other than listed for this unit.
- Under no circumstances open the lid of the centrifuge while the rotor is still running or rotating with a speed of >2m/s.

1.7.6 Abbreviations Used In This Instruction Manual

Symbol/Abbreviations	Unit	Description
RPM	[min ⁻¹]rpm	revolutions per minute
RCF	[x g]	relative centrifugal force
PCR		Polymerase chain reaction
PP	-	Polypropylene
PC	-	Polycarbonate
accel	-	acceleration
decel	-	deceleration
prog	-	program

2 INSTALLATION

2.1 Delivery Package

- Centrifuge
- Power cable
- Warranty Card
- Rotor Key
- Download Guide

Please note: The centrifuge and the accessories non-sterile.

2.2 Unpacking the Centrifuge

Carefully remove your centrifuge and each of its components from the package. The included components vary depending on the centrifuge model. Save the packaging to ensure safe storage and transport.

Rotor(s) / Accessories will be packed separately.



WARNING!

Lifting Hazard. Single person lift could cause injury. Use a mechanical lifting device or team lifting procedures when lifting or moving the equipment. Always lift the centrifuge on both sides.



ATTENTION!

Do not lift the centrifuge from under the lid or by the front panel! See correct lifting in the **Figure 1**.



Figure 1

With the help of the download guide and the included QR-code, you can download the user manual in different languages. The download guide must always be kept with the centrifuge. On our website you have access to the latest version of the user manual.

2.3 Space Requirements



ATTENTION!

Avoid excessive vibrations, heat sources, air current, or rapid temperature changes.

- When choosing a location for the refrigerated models FC5513R and FC5515R, consider the minimum room volume provided in table 9.1.3 and 9.1.5.
- The centrifuge should be installed on an even, solid and level surface, if possible, on a laboratory cabinet, table, or some other solid vibration free surface.
- During centrifugation, the centrifuge must be placed in a way, that there is a minimum space of 30 cm on each side of the unit according to the standards EN 61010-2-020.
- Do not place the centrifuge next to a window or a heater, where it could be exposed to excessive heat, as the performance of the unit is based on an ambient temperature of 23°C.

2.4 Installation

Follow these steps:

- Check whether the power supply corresponds with the one specified on the manufacturer's rating label, which is located on the rear panel.
- The power line should be protected by a 10 A rating circuit breaker (type K).
- In case of emergency, there must be an emergency switch off installed outside the room in order to disconnect the power supply from the unit.
- Connect the centrifuge to a grounded power receptacle.
- Connect the centrifuge with the mains. (The socket for the power cord must be easy to reach for disconnection)
- Switch on the centrifuge by using the mains power switch.
- Open the lid by using the Door Open button.
- Remove the transport securing device of the motor.

2.5 Safety Precautions During Operation

- Do not operate the centrifuge in case it is not installed correctly.
- Do not lean on the centrifuge during operation.
- Do not stay within the 30 cm clearance envelope longer than necessary for operational reasons.
- Do not place any potentially hazardous materials within the 30 cm clearance envelope.
- Do not operate the centrifuge when disassembled (e.g. without housing).
- Do not run the centrifuge when mechanical or electrical components have been tampered with.
- Do not use accessories such as rotors and buckets, which are not exclusively approved by OHAUS Corporation, except commercially available centrifuge tubes made of glass or plastic.
- Do not spin extremely corrosive substances, as they may damage or weaken the materials.
- Do not operate the centrifuge with rotors or buckets, which show any signs of corrosion or mechanical damage.
- The manufacturer is responsible for safety and reliability of the centrifuge, only if:
 1. The unit is operated in accordance with this instruction manual.
 2. Modifications, repairs, or other adjustments are performed by OHAUS authorized personnel, and the electrical installation complies with the relevant electrical code.

2.6 Warranty

The centrifuge has been subjected to thorough testing and quality control. In the unlikely case of any manufacturing faults occurring, the centrifuge and rotors are covered by warranty. The warranty depends on the region and is valid from date of delivery. This warranty becomes invalid in any case of mishandling, damage and/or negligence and further in any case of usage of inappropriate spare parts and / or accessories or unauthorized modification of the unit.

Technical modification rights are reserved, by the manufacturer, in regard to technical improvement!

3 OPERATION

3.1 Operating and Display Elements

FC5515R, FC5515

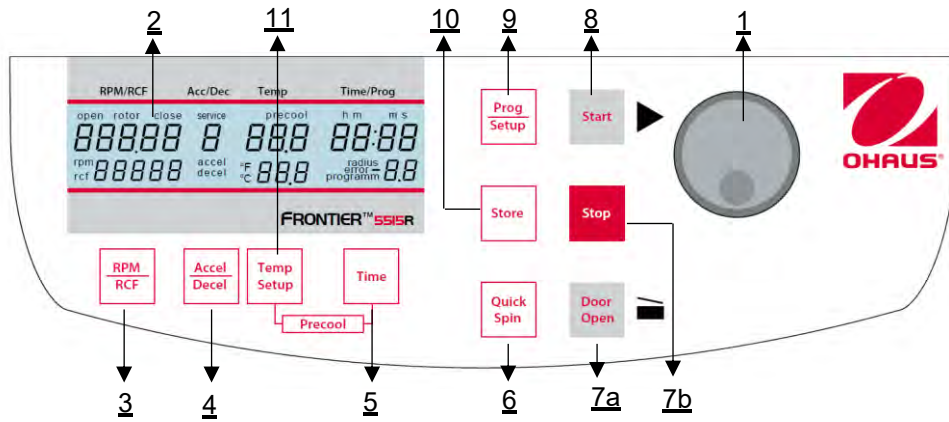

FC5513R, FC5513, FC5513L

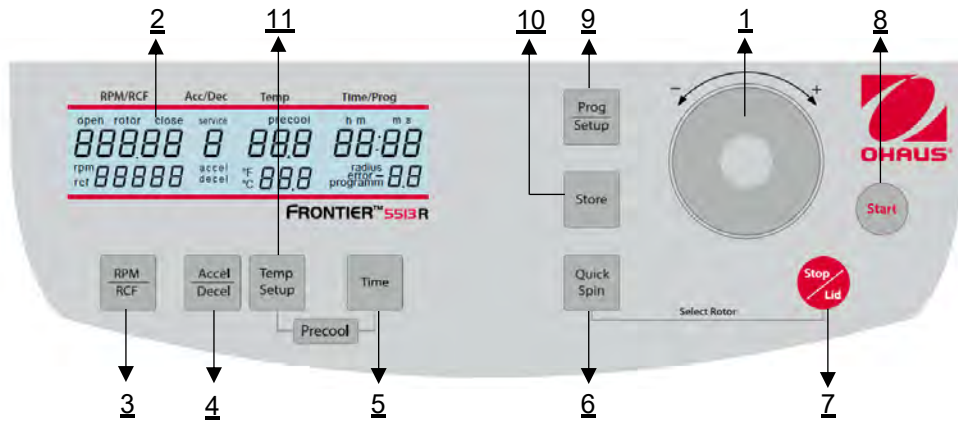

- | | | |
|----|--------------------------------|---|
| 1 | Adjusting knob/
Touch wheel | Run Parameters |
| 2 | LCD | Control Panel Display |
| 3 | RPM/RCF | Speed/ g-Force |
| 4 | Acc/Dec | Acceleration / Deceleration Intensity |
| 5 | Time | Centrifugation Time |
| 6 | Quick Spin | Short Running |
| 7 | Stop/Lid | Stop Centrifugation/Lid Release |
| 7a | Door Open | Lid Release |
| 7b | Stop | Stop Centrifuge |
| 8 | Start | Start Centrifugation |
| 9 | Prog/Setup | Retrieving Stored Programs |
| 10 | Store | Program Store |
| 11 | Temp Setup | Temperature Setup (FC5513R and FC5515R) |

3.2 LCD Display

Refrigerated models

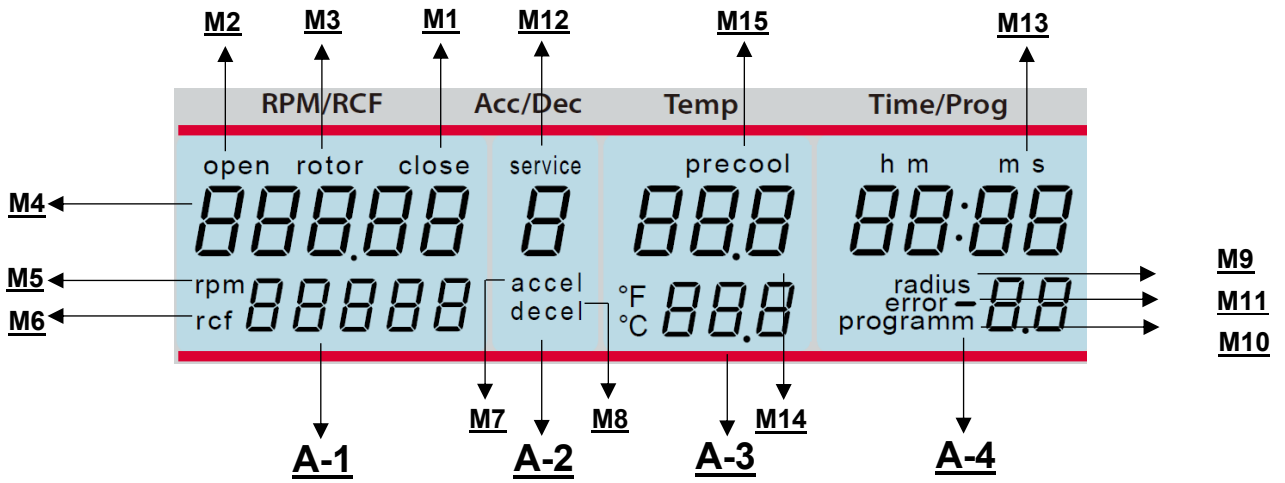

Non-refrigerated models

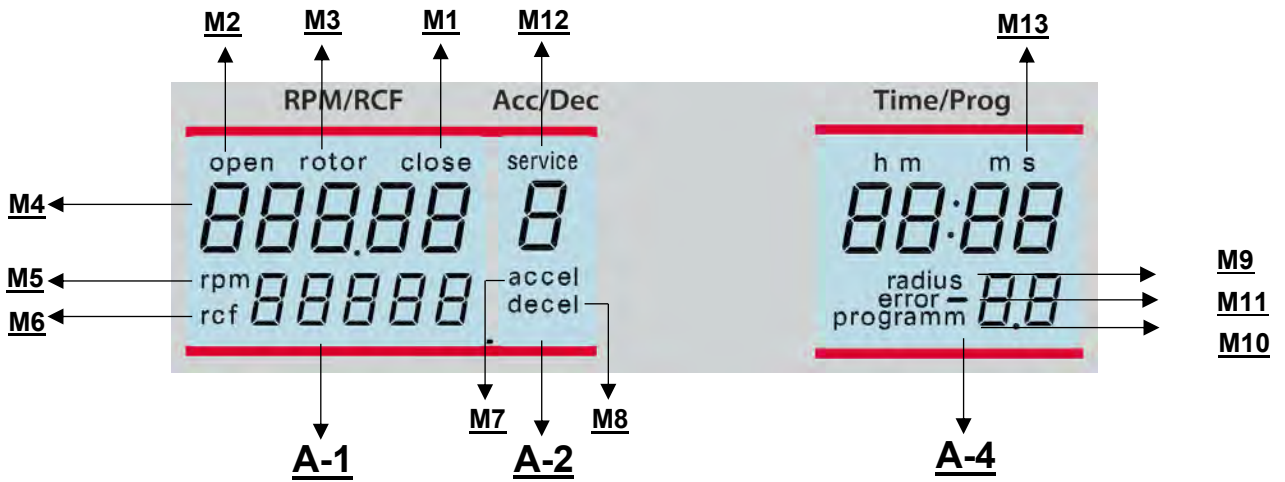

Display Fields:

- A1** Display Field – “RPM/RCF”
- A2** Display Field – “Acc/Dec”
- A3** Display Field – “Time/Prog”
- A4** Display Field – “Temp”

Messages on the Display Fields:

M1	“close”	M9	“radius”
M2	“open”	M10	“program”
M3	“rotor”	M11	“error”
M4	Rotor-No.	M12	“service”
M5	“rpm”	M13	h:m:s
M6	“rcf”	M14	temperature
M7	“accel”	M15	“precool”
M8	“decel”		

3.3 Rotors

3.3.1 Overview

Rotor ID	Order No.	Description	Compatible with				
			FC5513L	FC5513	FC5513R	FC5515	FC5515R
06	83041006	Rotor Angle 18x1.5/2.0ml	•		•		
02	30472302	Rotor Angle 24x1.5/2.0ml BIOSEALS V1		•	•		
14	83041014	Rotor Angle 4x8-Place PCR Stripes V1		•	•		
98	30210898	Rotor Angle 24x2.0ml Spin Column		•			
04	30472304	Rotor Hematocrit 24xCapillaries V1		•			
17	30372717	Rotor Angle 44x1.5/2.0ml V1				•	•
50	83041050	Rotor Angle 24x2.0ml Spin Column V1				•	•
71	30642371	Rotor Angle 24x1.5/2.0ml BIOSEALS V2				•	•
72	30130872	Rotor Angle 30x1.5/2.0ml Sealable				•	•
73	30130873	Rotor Angle 12x5ml FA Sealable				•	•
74	30130874	Rotor Angle 4x8-Place PCR Strip				•	•
07	83041007	Rotor Hematocrit 24xCapillaries V2				•	

3.3.2 Installation Of Rotors

Clean the drive shaft with a clean, grease-free piece of cloth (see Figure 2 and 4).

Place the rotor onto the motor shaft, hold the rotor with one hand and tighten the fixing nut clockwise with provided rotor key (see Figure 3 and 5).



Motor shaft and chamber
FC5513, FC5513L

Motor shaft and chamber
FC5513R

Figure 2



Rotor key

Figure 3



Motor shaft and chamber
FC5515R

Motor shaft and chamber
FC5515

Figure 4



Rotor key

Figure 5

**ATTENTION!**

Check that the fixing nut is properly installed before each run (see figures 3 and 5).

Do not operate the centrifuge with rotors or buckets which show any signs of corrosion or mechanical damage.

Do not operate with extremely corrosive substances, which could damage the rotor, buckets, and materials.

In case of any questions, please contact the manufacturer!

3.3.3 Change rotor ID / type of rotor (besides FC5513L)

Before the first operation and after each rotor change, you have to set the rotor ID. You find each rotor type in the printed order number on the rotor.

Example:

Angle rotor order number:

30642371 Rotor Type on the

display = 71

Turn on the centrifuge and open the lid. Now simultaneously press the keys "Quick Spin"(6) and "Stop/Lid"(7) at models FC5513 and FC5513R. Press simultaneously the keys "Door Open"(7a) and "Stop"(7b) at the models FC5515 and FC5515R. In the display "RPM/RCF" (A-1) the current rotor ID appears as well as the word "CHOOSE". With the adjusting knob/touch wheel (1) you can now set the needed rotor ID. To store the new setting please press the "Store"(10) or "Start" (8) key. Inside the display, "Store" appears as confirmation.

With that, all rotor specific data, like max. speed, acceleration etc., are adopted.

**ATTENTION:**

The set rotor type must always be the same as the actual rotor type used; otherwise, the equipment might be damaged.

The rotor type can be checked during the run by pressing the key "Quick Spin"(6).

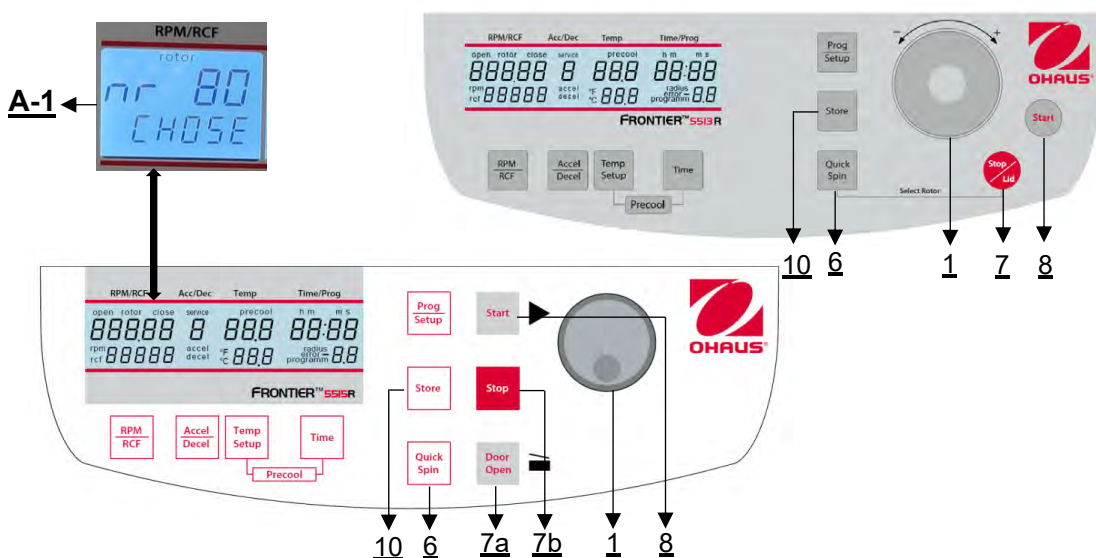

Figure 6

3.3.4 Loading Angle Rotors

Rotors must be loaded symmetrically and with equal weight (**see Figure 8**). The adapter may only be loaded with the appropriate vessels. The weight differences between the filled vessels should be kept as low as possible. Therefore, we recommend weighing them with a balance. This reduces the wear of the drive and the acoustic operating noise.

The maximum load per hole is stated on each rotor.



Figure 7 – WRONG



Figure 8 – CORRECT

3.3.5 Loading and Overloading of The Rotors

All approved rotors are listed with their maximum speed and maximum filling weight in "**Table 1: Permissible net weight**" (See APPENDIX).

The maximum load permitted for a rotor, which is determined by the manufacturer, as well as the maximum speed allowed for this rotor (see label on rotor), must not be exceeded. The liquids the rotors are loaded with should have a maximum homogeneous density of 1.2 g/ml or less when the rotor is running at maximum speed.

In order to spin liquids with a higher density, the speed has to be reduced according to the following formula:

$$\text{Reduced speed } n_{\text{red}} = \sqrt{\frac{1,2}{\text{higher density}}} \times \text{max. speed } (n_{\text{max}}) \text{ of the rotor}$$

Example:

$$n_{\text{red}} = \sqrt{\frac{1,2}{1,7}} \times 4.000 = 3.360 \text{ rpm}$$

To determine the relative centrifugal force (RCF/g-force) for a specific adapter, you can calculate using the attached formula:

$$\text{RCF} = 1.117862 \cdot 10^{-5} \cdot n^2 \cdot r_{\text{max}}$$

n: revolutions per minute (RPM)

rmax: max centrifuging radius in cm by using the bottom of tubes

In case of any questions, please contact the manufacturer!

3.3.6 Removing The Rotor

Untighten the rotor fixing nut completely counterclockwise and lift the rotor vertically out of the centrifuge.

3.4 Power switch

The power switch is located on the back side of the model FC5513 and FC5513L (see **Figure 9**). At the models FC5515R, FC5515 and FC5513R it's located at the front (see **Figure 10**).

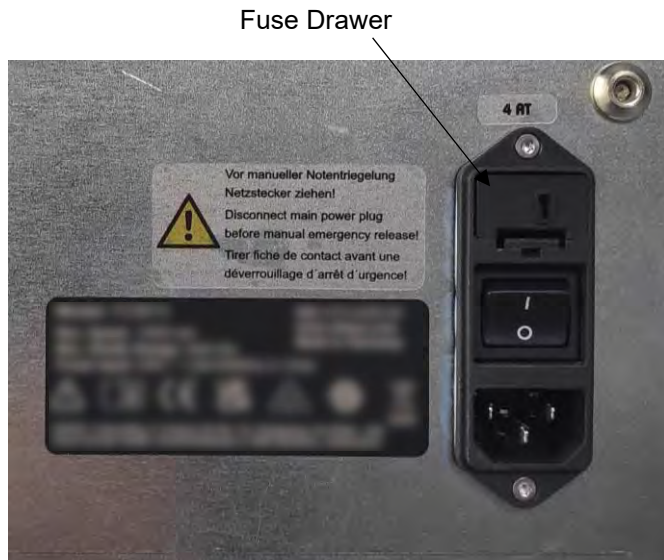

Figure 9 – FC5513, FC5513L



Figure 10 – FC5515R, FC5515, FC5513R

Fuse FC5513: 4 AT

Fuse FC5513L: 4 AT

3.5 Lid Control

3.5.1 Lid Open

After the run, when the lid of the centrifuge remains closed, the word **"close"** (M1) will continued to appear in the display **"RPM | RCF"** (A-1). At the same time the actual rotor ID, e.g. **"nr 80"**, is shown in the display (M4). As soon as the lid is released by pressing the key **"Door Open"** (7a) or **"Stop | Lid"** (7) or, the word **"open"** (M2) appears. Now you can open the lid of the centrifuge. Please refer to **Figure 11** below for reference.

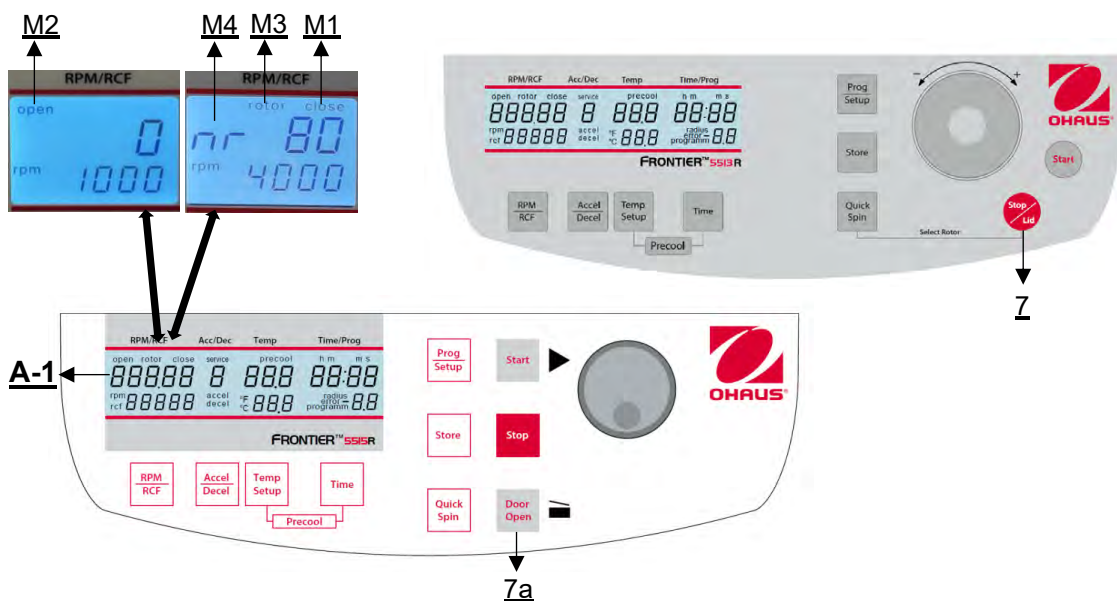

Figure 11

3.5.2 Lid lock

The lid should only be pushed down slightly. When the lid is locked, the word "open" (M2) is no longer displayed. As a sign that the centrifuge is ready for starting, in the display **"RPM | RCF"** (A-1) the word **"close"** (M1) appears. Simultaneously the word **"rotor"** (M3) is displayed, as well as the rotor ID, which is set in the centrifuge system, e.g. **"nr 80"** (M4).

Please refer to **Figure 11** for reference.



ATTENTION

Don't grip your fingers between lid and device or locking mechanism when closing the lid!
Before closing the lid please check if the rotor is tighten.

3.6 Preselection

3.6.1 Preselection of Speed / RCF-value

The pre-selection is activated through the key **"RPM | RCF"** (3) (refer to **Figure 12**). By pressing the key once the word **"rpm"** (M5) flashes. By pressing the key twice, the pre-selection of the centrifugal forces can be selected. Then the flashing word **"rcf"** (M6) appears. You can set the desired values with the adjusting knob / touch wheel (1). In the display (A-1) the regulated value is shown permanently, before, during and after the run.

As long as no rotor is inserted, the speed is adjustable between 200 rpm and maximum revolution of the centrifuge. If there is a rotor in the centrifuge the speed can only be pre-selected until the maximum permissible revolution of that rotor. It is the same with the pre-selection of the RCF-value. The setting range is between the minimum and maximum relative centrifugal force of the rotor.

See **"Table 2: max. speed and RCF-values for permissible rotor"** (APPENDIX). All important values are listed there.

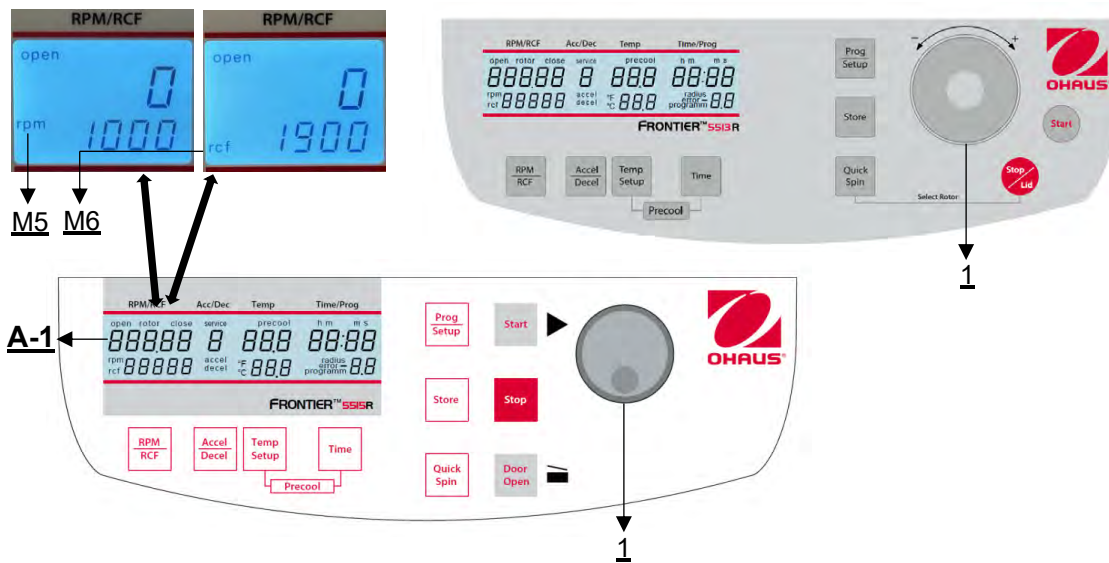

Figure 12



ATTENTION

Please also check the maximum permissible revolutions of your test tubes with the manufacturer.

3.6.2 Preselection of running time

The running time can be pre-selected in three different ranges from 10 seconds up to 99 hours 59 minutes.

- Range from: 10 seconds up to 59 minutes 50 seconds in steps of 10 seconds
- Range from: 1 hour up to 99 hours 59 minutes in steps of 1 minute.
- Range: Continuous run "**cont**", which can be interrupted by the key "**Stop**"(7b) or "**Stop | Lid**" (7).

The running time can be pre-selected with the lid open or closed.

To activate the setting of the running time, press the key "**Time**" (5).

In the display "**Time/Prog**" (A-4) flashes the indication "**m : s**" or "**h : m**", depending on the previous setting.

To set the desired value, use the adjusting knob / touch wheel (1). After exceeding 59 min 50 sec the indication changes automatically into "**h : m**". After exceeding 99 hours 59 min the word "**cont**" appears in the display "**Time/Prog**" (A-3). That continuous run can only be interrupted by pressing the key "**Stop**"(7b) or "**Stop | Lid**" (7). The time countdown starts as soon as the set speed is reached.

The display always shows the remaining running time (see Figure 13).

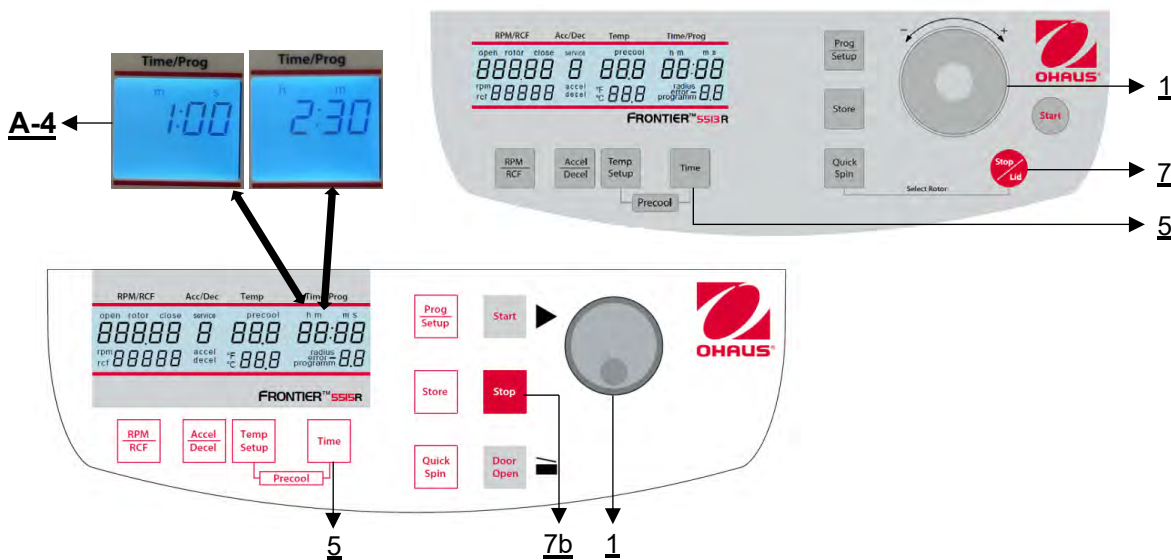

Figure 13

3.6.3 Preselection of acceleration and brake intensity (deceleration)

This function is activated through the key "**Accel/Decel**" (4) (refer to Figure 14).

By pressing the key once the word "**accel**" (M7) flashes in the display "**Acc/Dec**" (A-2). The desired acceleration can be pre-selected by the adjusting knob / touch wheel (1). The value 0 is equivalent to the lowest and the value 9 to the highest acceleration.

By pressing the key "**Accel/Decel**" (4) twice, the display "**Acc/Dec**" (A-2) indicates the word "**decel**"(M8). Now the desired brake intensity can be pre-selected by the touch wheel (1). The value 9 is equivalent to the shortest and the value 0 to longest possible brake time. A value of 0 corresponds to a free run-out without an active brake.

See "**Table 3: acceleration and deceleration times**" (APPENDIX). In this table the acceleration and deceleration times for the acceleration and deceleration stages 0 to 9 for permissible rotors are shown.

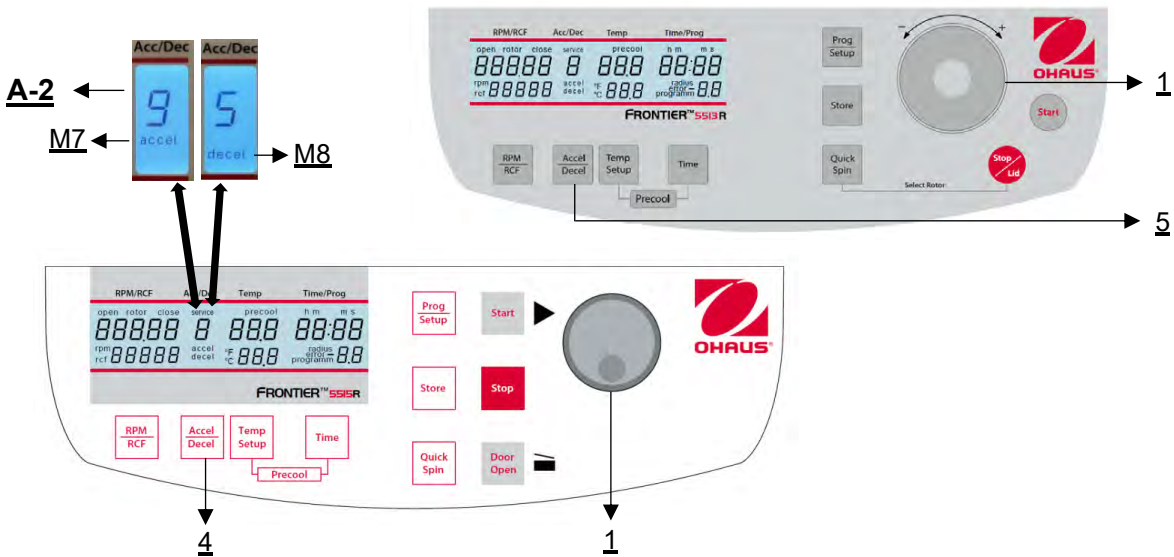

Figure 14

3.6.4 Preselection of temperature (Only FC5513R and FC5515R)

This function is activated by the key "Temp/Setup" (11). After pressing this key in the display "Temp" (A-3) the indication "°C" flashes. By the adjusting knob / touch wheel (1) the desired test temperature can be pre-selected in steps of 1°C in a range from -20°C up to +40°C.

The value is indicated permanently in the display (Figure 15) - before, during and after the run. Please notice the respective lowest temperatures of the rotors at maximum speed!

See "Table 4: Lowest temperature at max. speed" (APPENDIX).

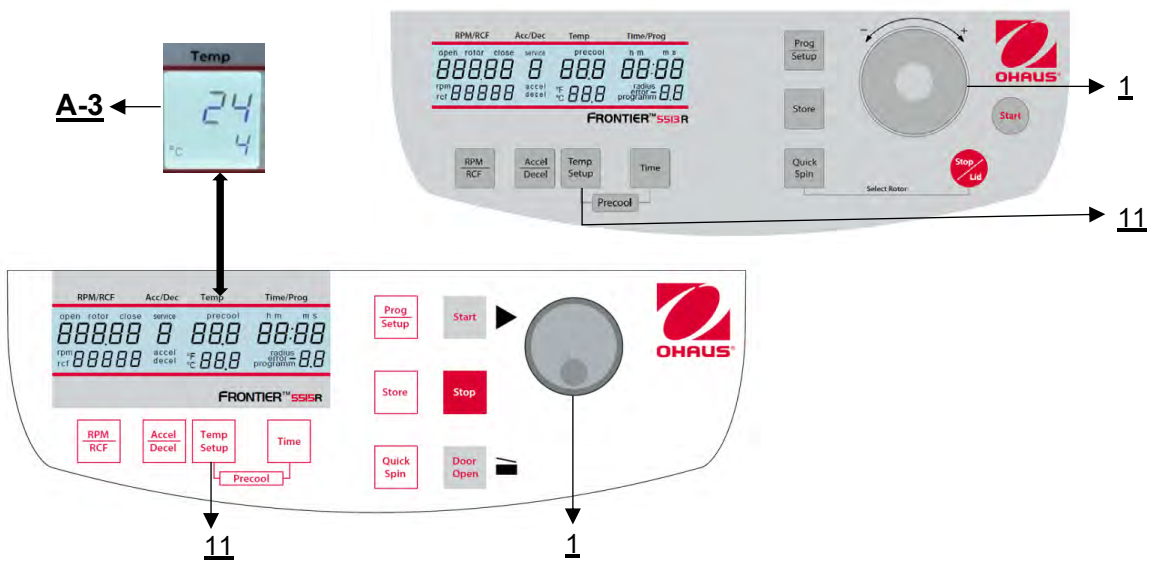

Figure 15

3.6.5 Pre-cooling (Only FC5513R and FC5515R)

If the samples are temperature-sensitive it is useful to pre-cool the centrifuge, the rotor and eventually the buckets to the required working temperature. Therefore, insert the desired rotor and pre-set the respective temperature. By simultaneous pressing the keys "**Temp/Setup**" (11) and "**Time**" (5) you can start the run (**Figure 16**). While running, the unit chooses automatically a rotational speed that is equivalent to 30 or 50 % of the permitted rotational speed of the respective rotor (depending on the rotor). After the pre-set temperature is reached you can leave the pre-cooling run with the key "**Stop**"(7b) or "**Stop | Lid**" (7).

Depending on the inserted rotor the pre-cooling goes between approx. 10 and 20 min.

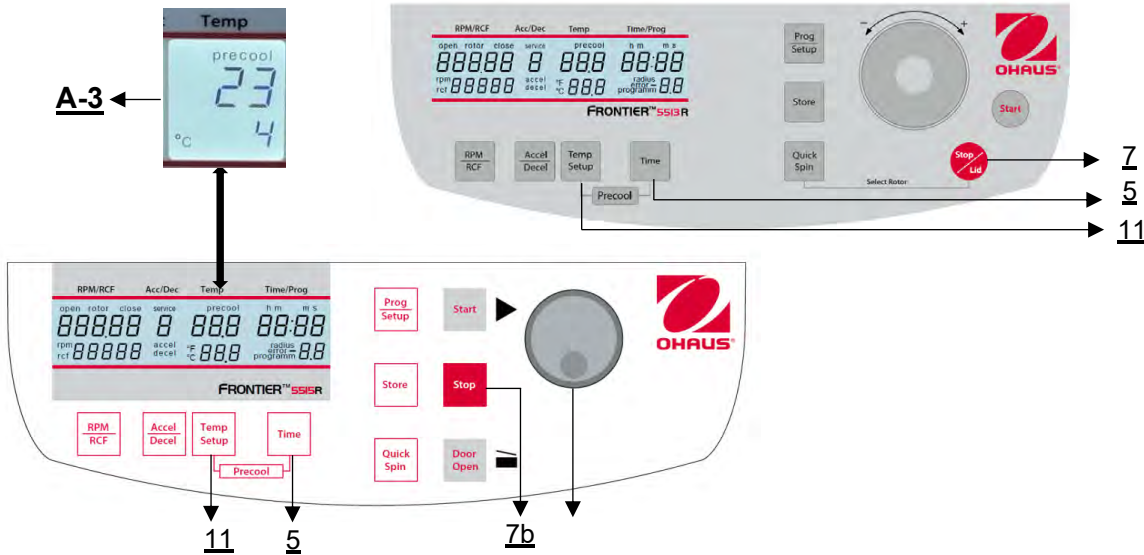

Figure 16

3.7 Radius correction

If you use adapters or reducers, it could change the centrifugal radius of the respective rotor. In that case you can correct the radius manually. Please proceed as follows:

First, close the centrifuge lid, then press the key "**Time**" (5) and the key "**Prog/Setup**" (9) at the same time and hold them (see **Figure 17**).

In the display "**Time/Prog**" (A-4) the word "**radius**" (M9) appears. By the touch wheel (1) you can preselect the respective radius correction, see "**Table 6: Radius correction**" (APPENDIX) in steps of 0.1 cm. As soon as you have set a radius correction the word "**radius**" (M9) appears. This word will be visible until you put the radius correction back to 0 again.

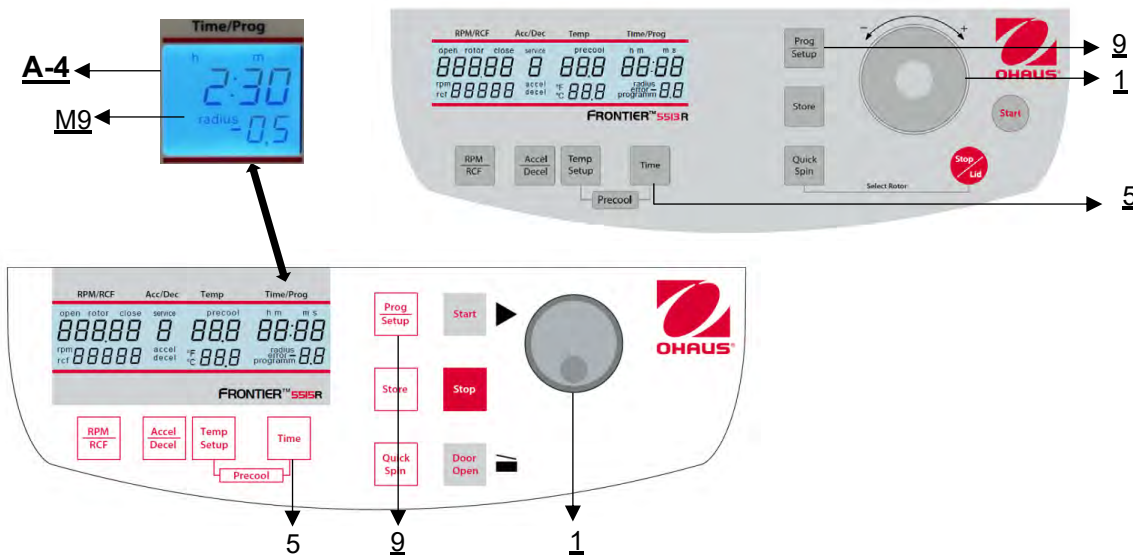

Figure 17

3.8 Program

3.8.1 Program storage

You can store up to 99 runs with all relevant parameters, including the used rotors. You can use any free program number and call it up again.

Put the needed rotor into the centrifuge and set the correct rotor ID according to chapter 3.3.3. By pressing the key **"Prog/Setup"** (9) in the display **"Time/Prog"** (A-4) the word **"program--"** (M10) appears. By the adjusting knob / touch wheel (1) you can chose the desired program number.

If a program number is already occupied, in the display **"RPM | RCF"** (A-1), the words **"rotor"** (M3) and **"xx"** (M4) will appear – the **"xx"** stands for the rotor ID. In case of free program numbers, 0 appears instead of rotor ID (see Figure 18).

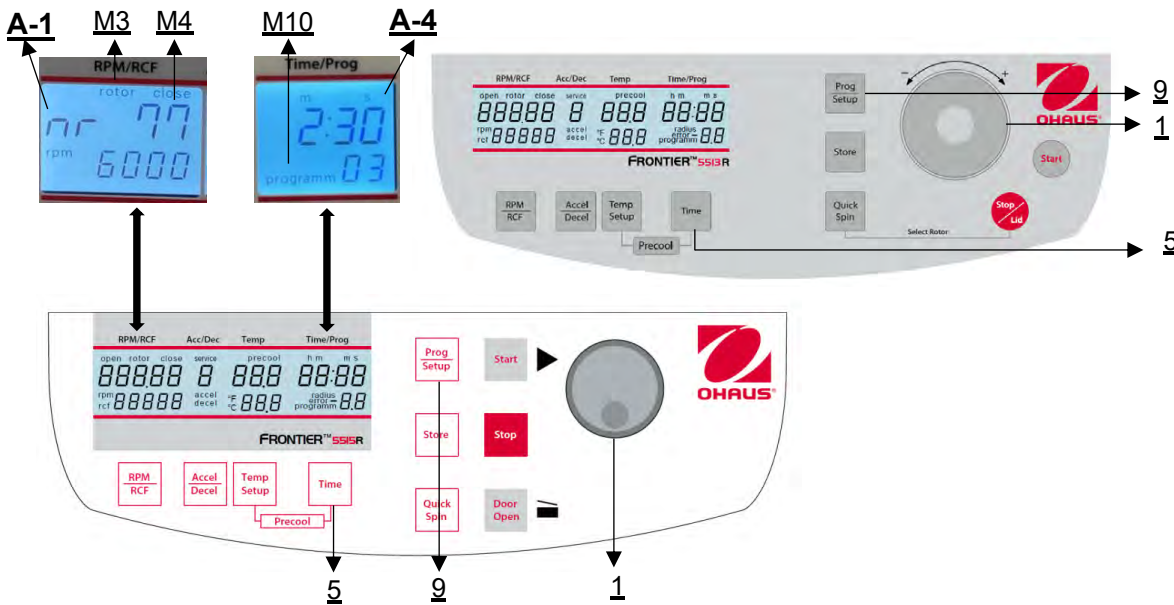

Figure 18

Close the lid of the centrifuge. Now proceed as described previously to set all important run parameters. If the lid isn't closed when storing the program, in the display **"RPM/RCF"** (A-1), the words **"FirSt"** and **"CLOSE Lid"** (see Figure 19) flashes alternately. If you want to start the run without storing the program, in the display **"RPM/RCF"** (A-1), the words **"First"** and **"PrESS StoreE"** (see Figure 20) flashes alternately.

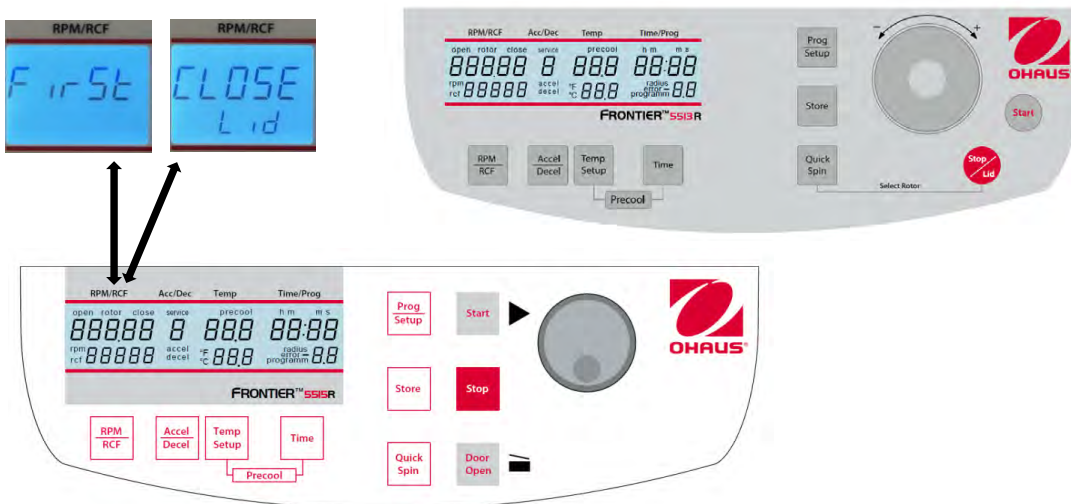

Figure 19

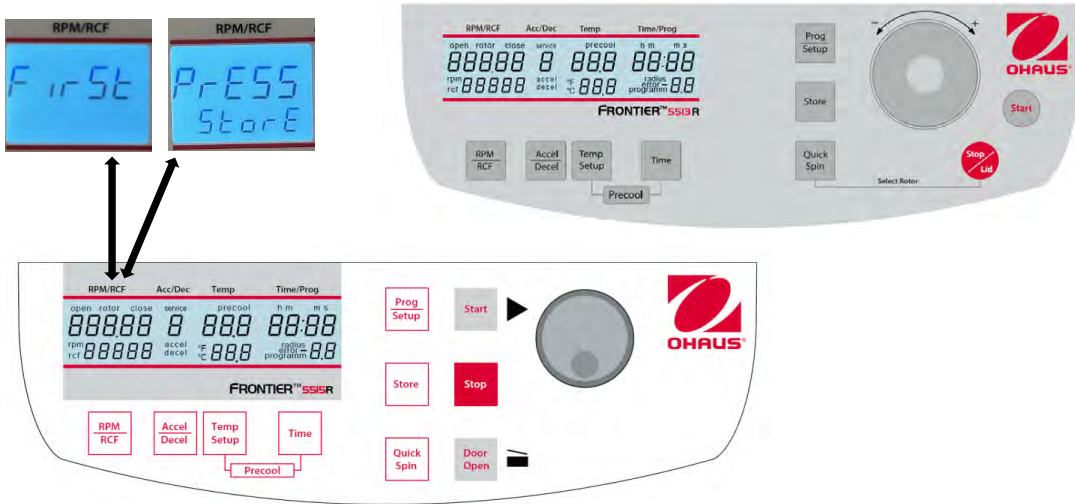

Figure 20

For adaption of data press the key **"Store"** (10) for approx. 1 second. If the program is stored correctly, the word **"StorE"** appears in the display **"RPM/RCF"** (A-1).

If all program numbers are occupied, you can take an old number that is not necessary anymore and just put in the new parameters.

3.8.2 Recall of stored programs

To recall stored programs, press the key **"Prog/Setup"** (9) (see Figure 21) while the lid is already closed. Inside the display **"Time/Prog"** (A-4), **"program--"** (M10) appears. The desired program number can be pre-selected with the touch wheel (1).

In the respective displays the stored values for that program will appear.

If according to chapter 3.3.3, the wrong rotor is set for the pre-selected program, in the display **"RPM | RCF"** (A-1), the word **"rotor"** (M3) flashes. At the same time the word **"FALSE"** and the stored rotor ID **"xx"** (M4) will be flashing by turns.

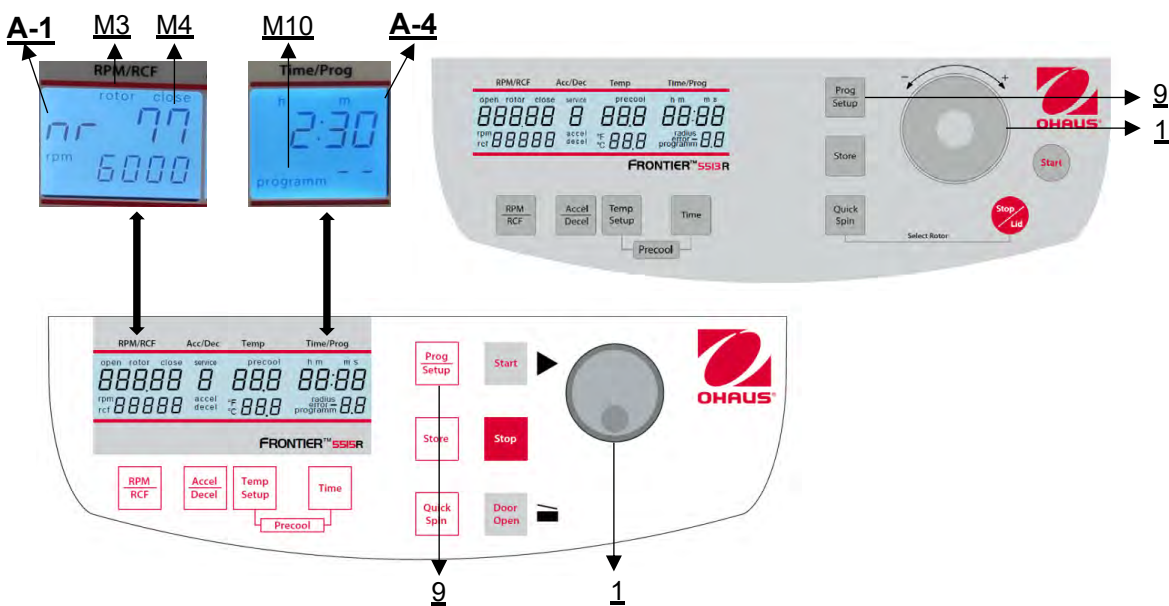

Figure 21

3.8.3 Leaving program mode

To leave the program mode just press the key "Prog/Setup" (9) (see Figure 21). Then inside the display "Time/Prog" (A-1) the word "programm" (M10) appears. Set the display to "programm--" (M10) with the touch wheel (1).

3.9 Starting and Stopping the Centrifuge

3.9.1 Starting the centrifuge

You can start the centrifuge either with the "Start" key (8) or the "Quick Spin" key (6) (see Figure 21). By the "Start" key (8) you can start stored runs or runs with manually pre-selected parameters. When the respective pre-selected running time has ended the centrifuge will stop automatically. By the "Quick Spin" key (6) you can start runs, which will last just a few seconds.

By pressing the "Quick Spin" key (6) the centrifuge accelerates up to the pre-selected revolution. In the display "Time/Prog" (A-4) the passed running time is indicated from the date of pressing the "Quick Spin" key (6). By releasing the "Quick Spin" key (6) the centrifuge stops, and the running time is indicated until the opening of the lid.

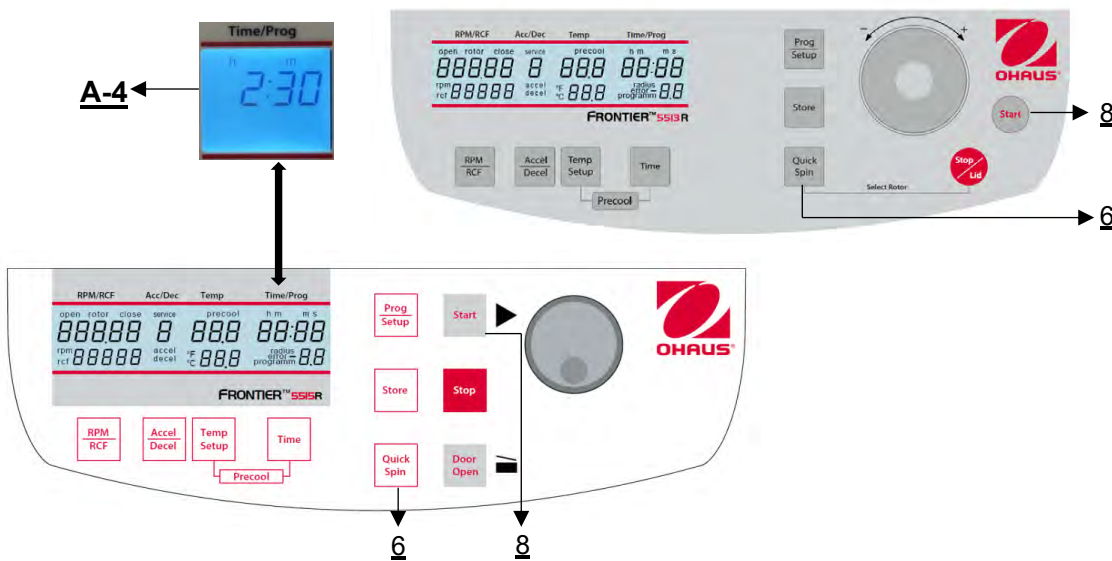

Figure 22

3.9.2 Stopping the centrifuge

By the "Stop" (7b) or "Stop/Lid" key (7) (see Figure 23) you can interrupt the run at any time. After pressing the key, the centrifuge decelerates with the respective pre-selected intensity down to stand still.

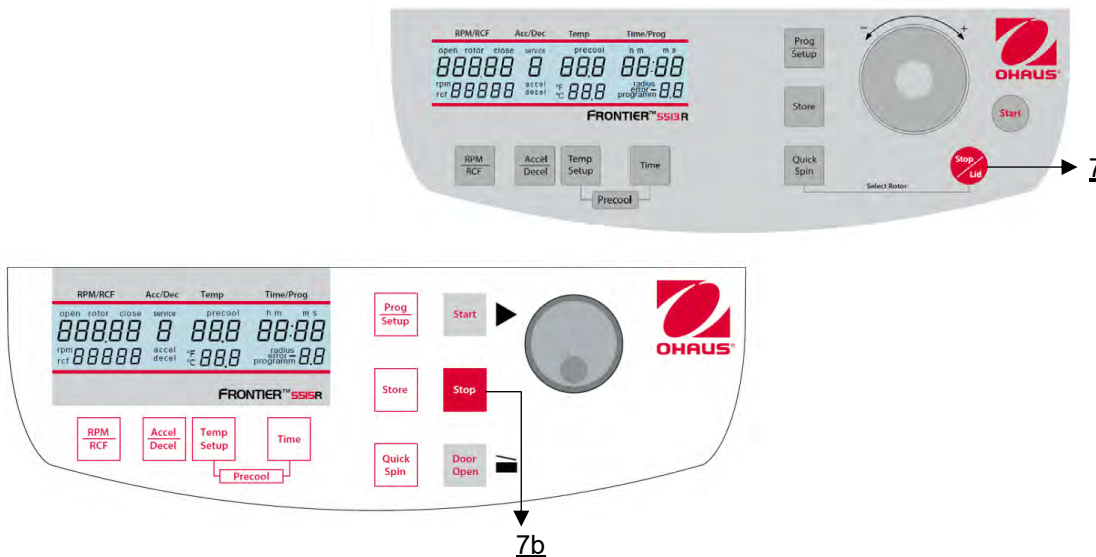

Figure 23

3.10 Imbalance Detection

In case of the rotor not being equally loaded, the drive will turn off during acceleration. The rotor decelerates to stand still.

When in the display **"Time/Prog"** (A-4) the word **"error"** (M11) together with the number **"01"** appear, the weight difference of the samples is too large. Distribute the weight evenly (**See picture 24**).

Load the rotor as described in chapter 3.3.4 and 3.3.5.

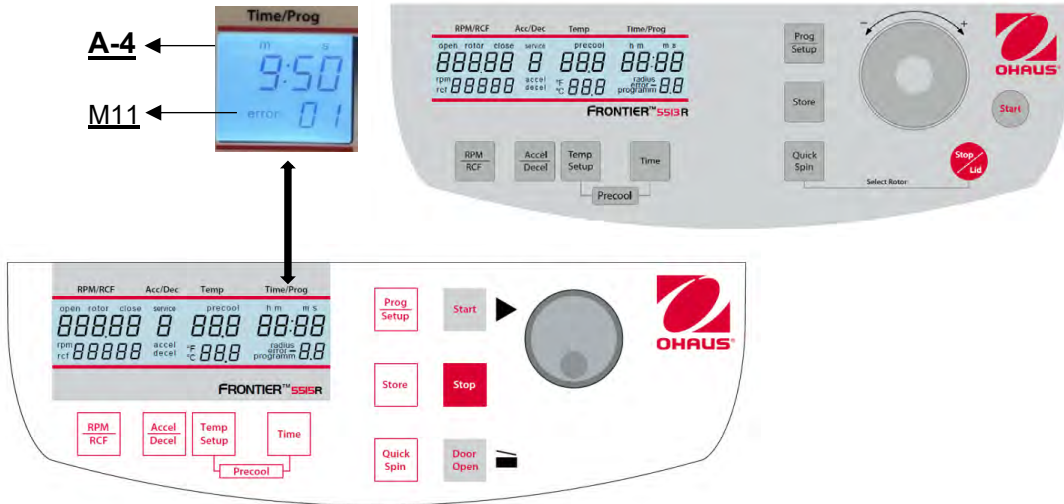

Figure 24

4 SETTING

4.1 Basic Adjustments

4.1.1 Access to mode “Operating Data”

When using the centrifuge, the following parameters can be set:

- Temperature indication in °C or °F (only FC5513R and FC5515R)
- Acoustic signal turn on/off
- Keyboard sound turn on/off
- Volume pre-selection of sound signal (only FC5515 and FC5515R)
- Song selection of sound signal **"end of run"** (only FC5515 and FC5515R)

The following operating data can be retrieved in this menu:

- Number of starts
- Operating hours of centrifuge
- Operating hours of motor
- Software version centrifuge
- Frequency converter software (only FC5515 and FC5515R)
- Error list
- Function of the imbalance sensor
- Intermediate Circuit Voltage in Volt (only FC5513L, FC5513 and FC5513R)
- Operation of keyboard
- Hardware version

Open the centrifuge lid and shut off the main switch. Now switch on again the main switch. For approximately 3 seconds the model name will be shown in the display as well as the current software version. Press during this time the keys **"Time"** (5) and **"Stop/Lid"** (7) simultaneously. As a result, a display test is executed for approx. 3 seconds. All indicators will appear at the same time (see Figure 25).

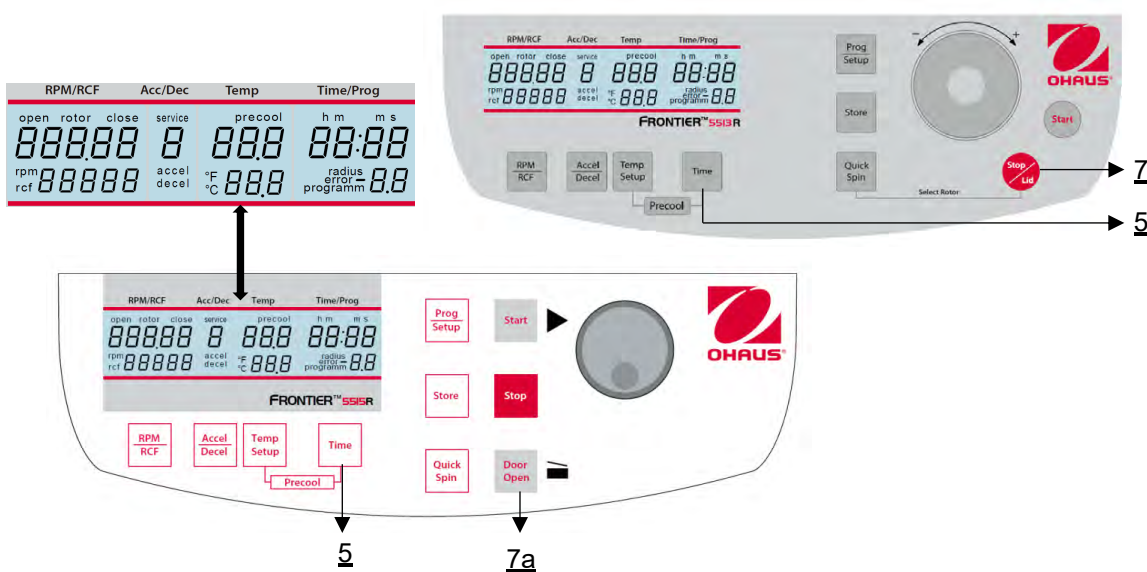

Figure 25



ATTENTION

All changed settings must be confirmed by the key **"Start"**(8) or **"Store"** (10). The word **"Store"** appears in the display **"RPM | RCF"** (A-1) – Only then the pre-selections are valid (see **Figure 26**). After you have stored the settings, you can change to normal program mode again by switching off the centrifuge for a short while.

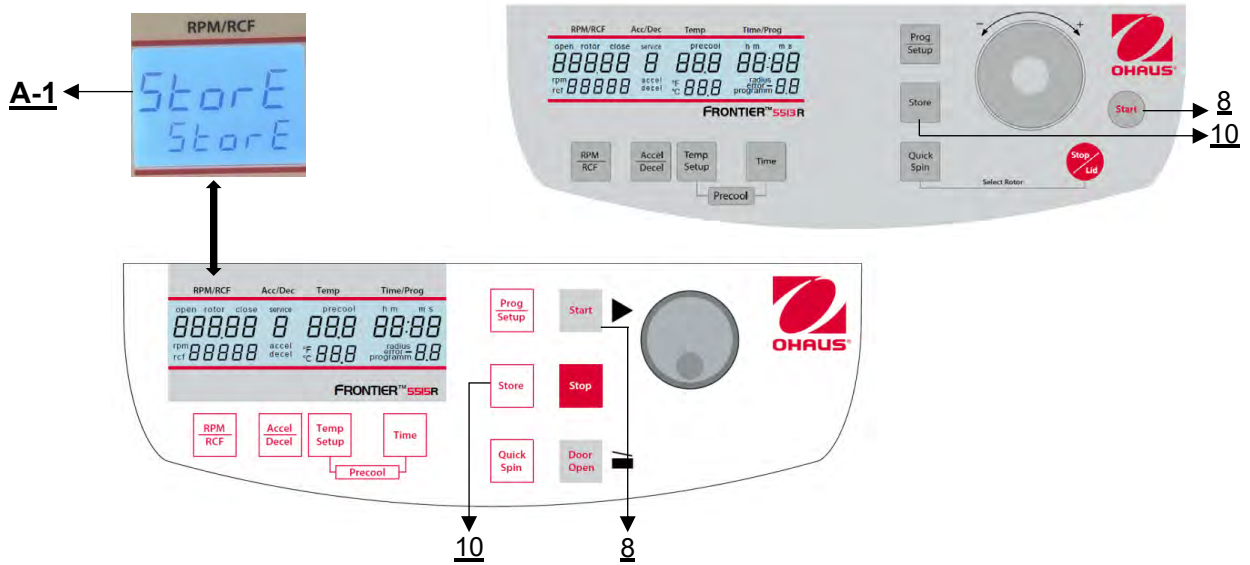

Figure 26

4.1.2 Temperature indication in °C or °F (only FC5513R and FC5515R)

Proceed as described under point 4.1.1 to enter this program mode and then press the key **"Accel/Decel"** (4). In the display **"Acc/Dec"** (A-2) the word **"Service"** (M12) flashes. Now select the letter **"C"** with the adjusting knob / touch wheel (1). As a result, the words **"CELSI/temp"** appear in the display **"RPM | RCF"** (A-1). If you press the key **"RPM | RCF"** (3), the word **"°C"** flashes and you can change the display into Fahrenheit **"°F"** with the adjusting knob / touch wheel (1) (see **Figure 27**).

After you have stored the settings (see 4.1.1) you can change back to the normal program mode again by switching off the centrifuge for a short while.

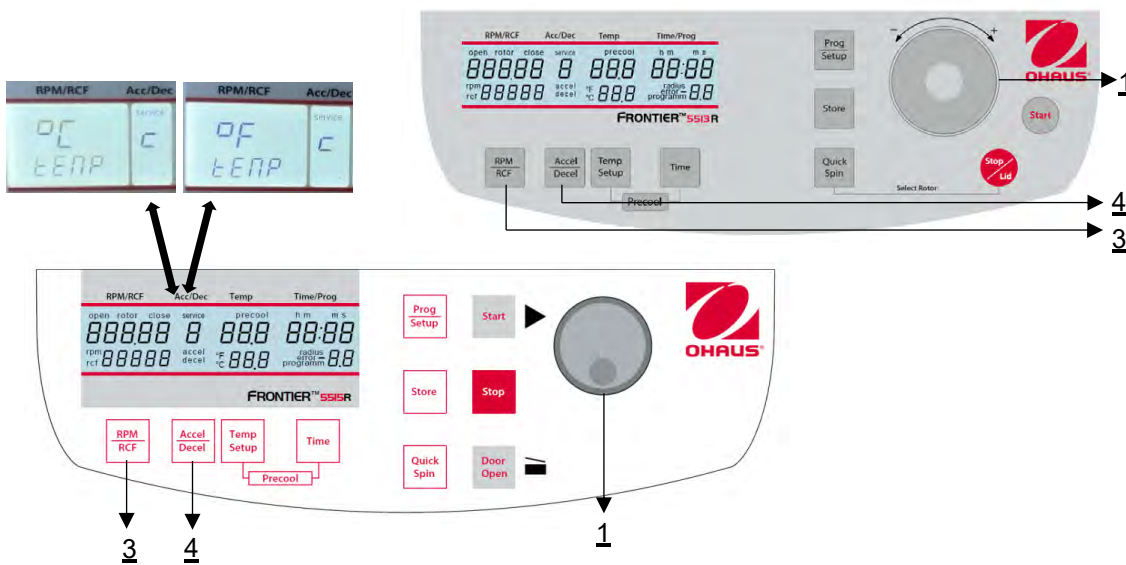

Figure 27

4.1.3 Acoustic signal turn on /off

Proceed as described under point 4.1.1 to enter this program mode and then press the key **"Accel/Decel"** (4). In the display **"Acc/Dec"** (A-2) the word **"Service"** (M12) flashes. Now select the letter **"L"** with the adjusting knob / touch wheel (1). As a result, the words "On Sound" appear in the display **"RPM | RCF"** (A-1). If you press the key **"RPM | RCF"** (3), the word **"On"** flashes and you can switch off the sound with the adjusting knob / touch wheel (1) (see Figure 28).

After you have stored the settings (see 4.1.1) you can change back to the normal program mode again by switching off the centrifuge for a short while.

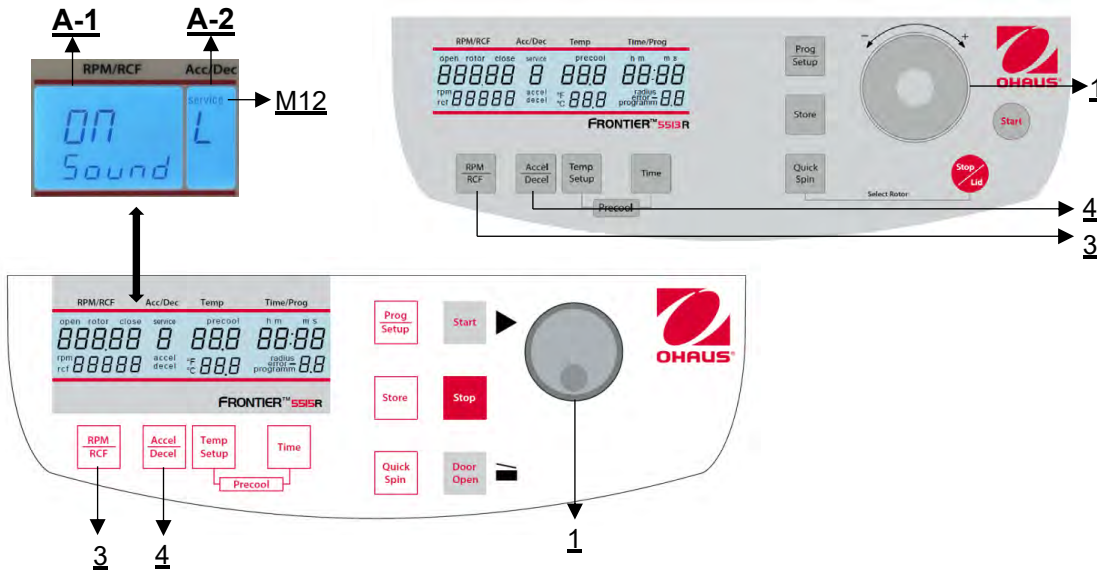

Figure 28

4.1.4 Volume pre-selection sound signal (only FC5515 and FC5515R)

Proceed as described under point 4.1.1 to enter this program mode and then press the key **"Accel/Decel"** (4). In the display **"Acc/Dec"** (A-2) the word **"Service"** (M12) flashes. Now select the letter **"U"** with the adjusting knob / touch wheel (1). As a result, the words "Vol=9/Sound" appear in the display **"RPM | RCF"** (A-1). After pressing the key **"RPM | RCF"** (3), you can adjust the desired volume between 0 (low) and 9 (loud) with the adjusting knob / touch wheel (1) (see Figure 28).

After you have stored the settings (see 4.1.1) you can change back to the normal program mode again by switching off the centrifuge for a short while.

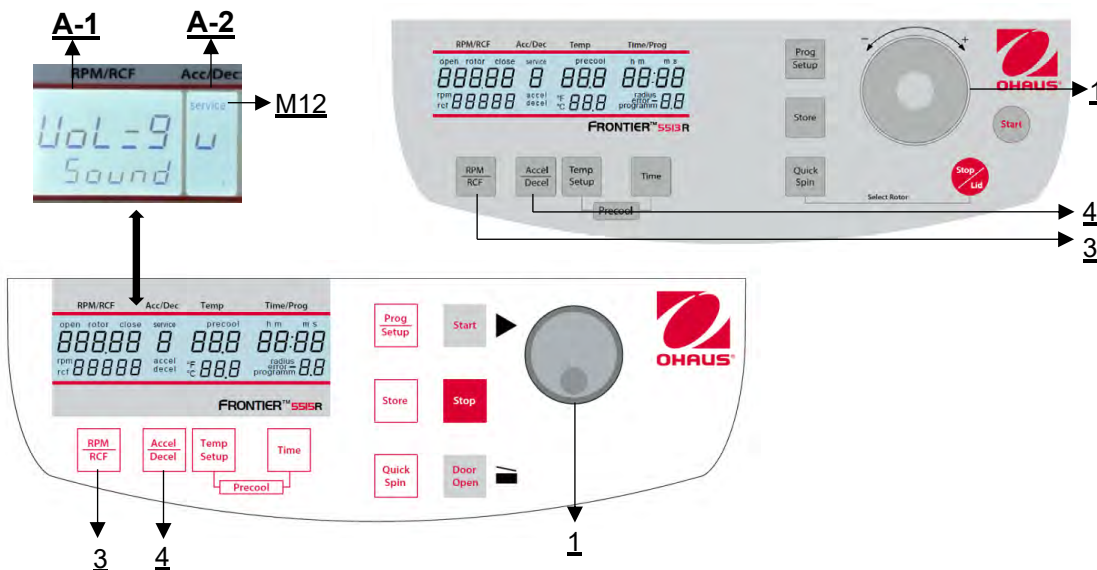

Figure 28

4.1.5 Song selection for sound signal – end of run (only FC5515 and FC5515R)

Proceed as described under point 4.1.1 to enter this program mode and then press the key **"Accel/Decel"** (4). In the display **"Acc/Dec"** (A-2) the word **"Service"** (M12) flashes. Now select the letter **"G"** with the adjusting knob / touch wheel (1). As a result, the words **"SonGo/Sound"** appear in the display **"RPM | RCF"** (A-1). After pressing the key **"RPM | RCF"** (3), you can select a song with the adjusting knob / touch wheel (1) (see **Figure 29**).

After you have stored the settings (see 4.1.1) you can change back to the normal program mode again by switching off the centrifuge for a short while.

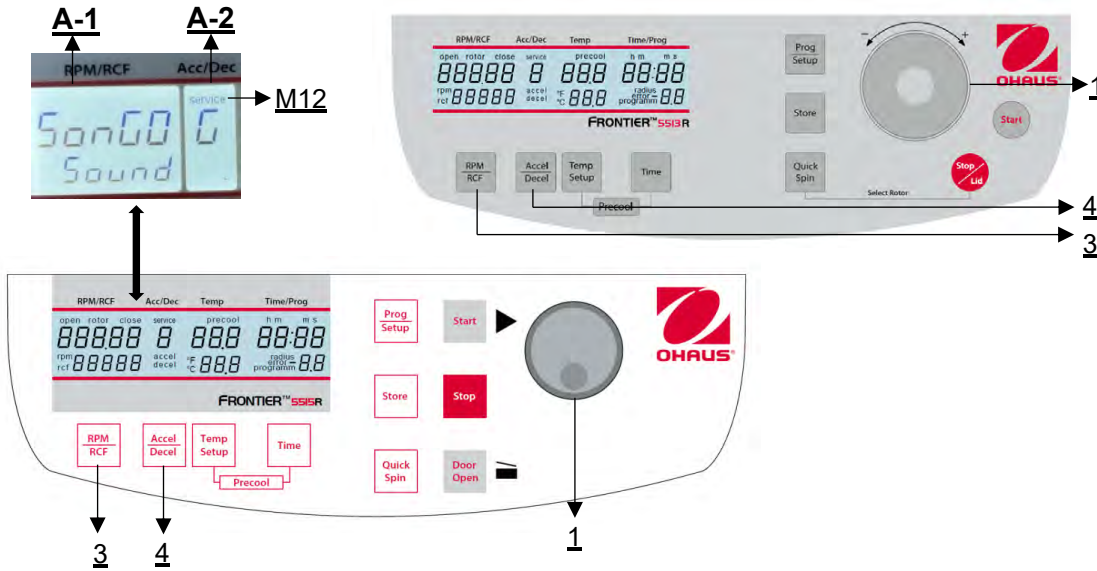

Figure 29

4.1.6 Keyboard sound turn on /off

Proceed as described under point 4.1.1 to enter this program mode and then press the key **"Accel/Decel"** (4). In the display **"Acc/Dec"** (A-2) the word **"Service"** (M12) flashes. Now select the letter **"b"** with the touch wheel (1). As a result, in the display **"RPM | RCF"** (A-1), the word **"ON/BEEP"** appears. After pressing the key **"RPM | RCF"** (3), you can turn the keyboard sound (On) or (Off) with the touch wheel (1) (see **figure 30**).

After you have stored the settings (see 4.1.1) you can change back to the normal program mode again by switchoff the centrifuge for a short while.

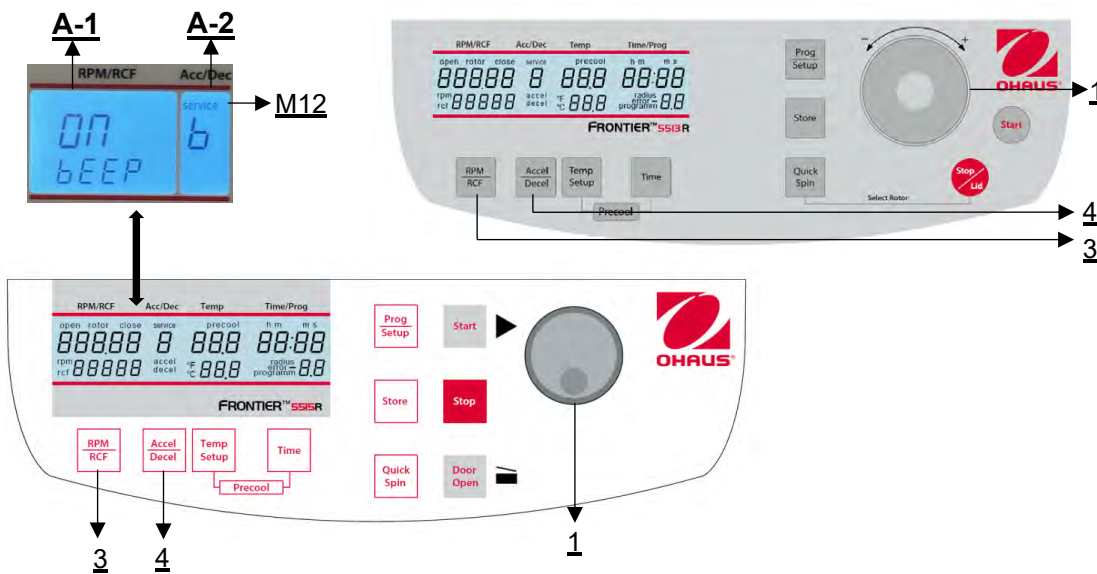

Figure 30

4.1.7 Call up operating data

In the mode **"Basic Adjustments"** you can call up the operating data of the centrifuge. Please proceed as described under point 4.1.1 to enter this program mode. Press the key **"Accel/Decel"** (4). In the display **"Acc/Dec"** (A-2) the word "Service" (M12) flashes.

With the adjusting knob / touch wheel (1) the different information can be accessed:

- A = previous starts of the centrifuge
- H = previous operating hours
- h = running time of the motor
- S = software version
- r = frequency converter software
- E = list of previous error messages
- F = Function of the Imbalance Sensor
- U = Intermediate Circuit Voltage in Volt
- P = Operation of keyboard
- d = Hardware Version

The list of the last 99 error messages can be looked over by pressing the key **"RPM | RCF"** (3) and scroll through it by the adjusting knob / touch wheel (1). The respective error codes appear in the display **"RPM | RCF"** (A-1). Please refer to **"Table 5: error messages"** (see APPENDIX).

To change back to normal program mode again, switch off the centrifuge for a short period.

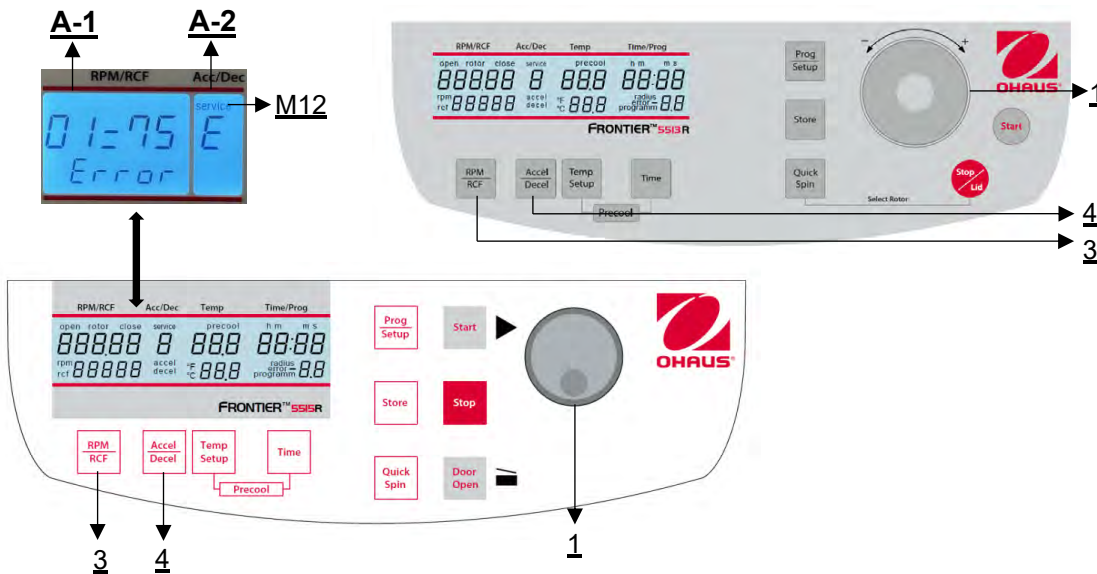

Figure 31

5 MAINTENANCE

5.1 Maintenance and cleaning

5.1.1 General Care

Maintenance of the centrifuge by the end user is confined to keeping the rotor, the rotor chamber, and the rotor accessories clean as well as to regularly lubricating the rotor insert bolts of a swing out rotor (if available).

Suitable lubricant can be order under this order number: 30314586. Own lubricants containing molycote and graphite are not allowed.

Please pay special attention to anodized aluminum parts (if available). Breakage of rotors can be caused even by slight damage. In case of rotors, buckets or tube racks getting in touch with corrosive substances the concerned spots have to be cleaned carefully.

Corrosive substances are for instance: alkalis, alkaline soap solutions, alkaline amines, concentrated acids, solutions containing heavy metals, water-free chlorinated solvents, and saline solutions. e.g. salt water, phenol, halogenated hydrocarbons.

Maintenance and repairs may only be performed by persons authorized by the manufacturer to avoid the risk of possible ignition in refrigerated models due to incorrect parts or improper maintenance. The refrigerated models must have an annual leaks inspection.

5.1.2 Cleaning – centrifuges, rotors, accessories

- Turn the device off and disconnect it from the power supply before you begin any cleaning or disinfecting. Do not pour liquids into the housing interior.
- Do not spray disinfectant on the device.
- Thorough cleaning not only has its purpose in hygiene but also in avoiding corrosion due to pollution.
- In order to avoid damaging anodized parts such as rotors, reduction plates etc., only pH-neutral detergents with a pH-value of 6-8 may be used for cleaning. Alkaline cleaning agents (pH-value > 8) must not be used. After cleaning, please ensure all parts are dried thoroughly, either by hand or in a hot-air cabinet (max. temperature + 50°C).
- It is necessary to coat anodized aluminum parts with anti-corrosion oil regularly in order to increase their life-spans and reduce corrosion predisposition.
- Due to humidity or not hermetically sealed samples, condensate may be formed. The condensate has to be removed from the rotor chamber with a soft cloth regularly.



NOTE!

The maintenance procedure must be repeated every 10 to 15 runs, or at least once a week.

- Connect the unit to the power supply, after the equipment is completely dry.
- Do not carry out disinfection with UV-, beta- and gamma-rays or other high energy radiation.

5.1.3 Centrifuge cleaning and disinfection

- Open the lid before you turn off the unit. Disconnect it from the power supply.
- Remove the rotor screw or nut by turning counterclockwise.
- Remove the rotor.
- For cleaning and disinfection of the unit and the rotor chamber use the above-mentioned cleaner.
- Clean all accessible areas of the device and its accessories, including the power cord with a damp cloth.
- Wash the rubber seals and rotor chamber thoroughly with water.
- Rub the dry rubber seals with glycerol or talc to prevent these to becoming brittle. Other components of the unit, e.g. motor shaft and rotor cone must not be greased.
- Dry the motor shaft with a soft, dry, and lint-free cloth.
- Control the unit and accessories for damage.

5.1.4 Cleaning and disinfection of the rotors

- Clean and disinfect the rotors and adapters with the cleaner, previously mentioned above.
- Use a bottle brush to clean and disinfect the rotor bores.
- Rinse the rotor and adapter, with clear water. Particularly, the drillings of the angle rotors.
- When drying the rotor and adapter, set on a towel. Place the angle rotor, with bores down, to dry.
- Dry the rotor cone with a soft, dry, and lint-free cloth, check for damage. Do not grease the rotor cone.
- Put the dry rotor back on the motor shaft.
- Fix the rotor by turning the rotor screw or nut clockwise.

5.1.5 Disinfection of rotors

In case of infectious material spilling into the rotor, it must be disinfected directly after the run.

Autoclaving

The recommended time for autoclaving: 15-20 min at 121°C (2,15 bar)



ATTENTION!

The sterilization time of 20 min. must not be exceeded. Repeated sterilization will cause reduction of the mechanical resistance of the plastic material.

Before autoclaving the PP-rotor and adapter must be thoroughly cleaned to avoid the burning in of dirty residues. You can disregard the consequences of some chemical residues to plastic materials at ambient temperatures. But at the high temperatures during autoclaving those residues may corrode and destroy the plastic. The objects must be thoroughly rinsed with distilled water after the cleaning but before the autoclaving. Residues of any cleaning liquids may cause fissures, whitening and stains.

Gas sterilization

Adapters, bottles, and rotors may be gas sterilized with Ethylenoxyd. Make sure to air out the items after the sterilization and before using them again.



ATTENTION!

Because the temperature may rise during the sterilization, rotors, adapters, and bottles must not be closed and must be totally unscrewed

Chemical sterilization

Bottles, adapters, and rotors may be treated with the usual liquid disinfectants.



ATTENTION!

Before applying any other cleaning or decontamination method than recommended by the manufacturer, contact the manufacturer to ensure that it will not damage the unit or the rotor.

5.1.6 Glass breakage

With high g-values, the rate of glass tube breakage increases. Glass splinters have to be removed immediately from rotor, buckets, adapters, and the rotor chamber itself. Fine glass splinters will scratch and therefore damage the protective surface coating of a rotor. If glass splinters remain in the rotor chamber, fine metal dust will build up due to air circulation. This very fine, black metal dust will significantly pollute the rotor chamber, the rotor, the buckets, and the samples.

If necessary, replace the adapters, tubes, and accessories to avoid further damage. Check the rotor bores regularly for residues and damage.



ATTENTION!

Please check the relevant specifications of the tube's centrifuges with the manufacturer.

5.2 Service life of rotors, buckets, accessories

Rotors and rotor lids made of metal have a maximum operating time service life of 7 years from first use. Transparent rotor lids and caps made of PC or PP, as well as rotors, tube racks, and adapters of PP, have a maximum operating time service life of up to 3 years from first use. The condition for the operating time is proper use, damage-free condition, recommended care, and no sign of corrosion or cracks.

- Before each run, please check if the accessories are damaged. Replace any and all damaged accessories.
- Rotors, rotor lids, buckets, adapters or caps, which are showing any signs of corrosion or mechanical damage, are not longer functional.
- Do not use any accessories which are past their operating life.
- Be aware when inserting buckets and rotors, ensure that they do not become scratched.
- Protect the equipment from damage.

6 TROUBLESHOOTING

6.1 Error messages: Cause / Solution

The error messages are listed to help localize possible errors faster.

The diagnosing referred to in this chapter may not always be the case, as they are only theoretically occurring errors and solutions.

6.2 Survey of possible failures and their solutions

6.2.1 Lid release during power failure (Emergency Lid Release)

In case of power failure or malfunction, the lid of the centrifuge can be opened manually in order to retrieve your samples.

Please proceed as follows for models **FC5513R**, **FC5513** and **FC5513L**:



- Switch the centrifuge off unplug the power cord, wait until the rotor stands still. This may take several minutes.
- At the right side of the centrifuge (**FC5513R**) there is a plastic stopper. At the **FC5513** and **FC5513L** the stopper is at the left side (see **Figure 32**). Remove this stopper, which is connected to the lid lock with a red string.
- Pull the string to open the centrifuge lid.

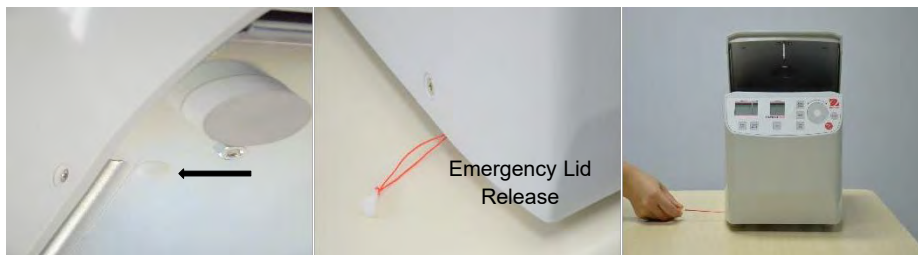

Figure 32

Please proceed as follows for models **FC5515R** and **FC5515**:



- Switch the centrifuge off unplug the power cord, wait until the rotor stands still. This may take several minutes.
- On the left side of the centrifuge housing there is a plastic stopper. Remove this stopper and behind it there is a hexagon nut.
- Take the included rotor key, put it in the hole and lock the rotor key with the hexagon nut (see **Figure 33**)
- Now turn the rotor key to the left side (counter clockwise) up to the limit. Don't tighten the nut! Now you can open the centrifuge lid.



Figure 33

6.2.2 Description of the error message system

The error message **"error"** (M11) is shown in the **"Time/Prog"** (A-4) display (see **Figure 33**). Detailed information about possible error messages is in: **"Table 5: error messages"** See APPENDIX.

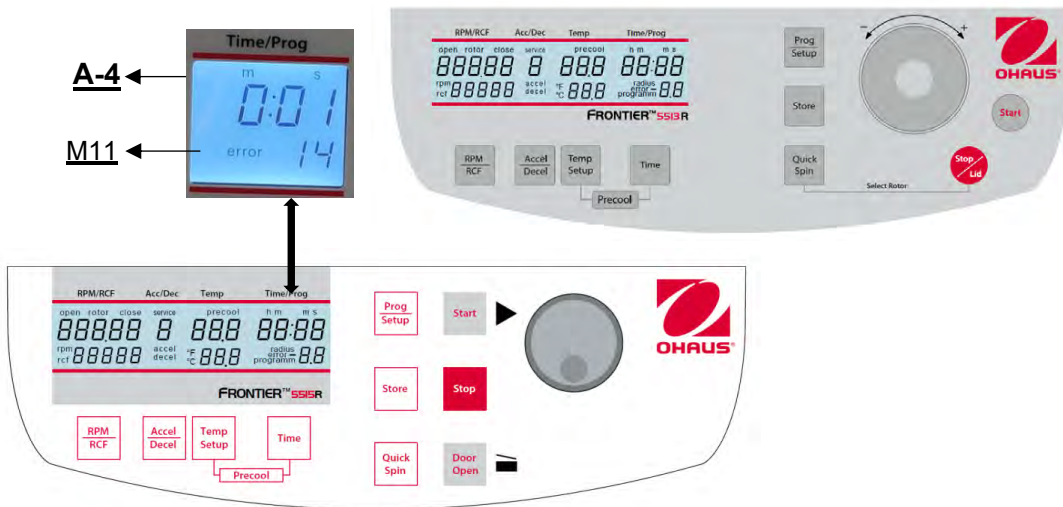

Figure 35

6.2.3 Procedure while error 14

If Error 14 occurs, there is a problem with the speed sensor. The centrifuge lid is closed for undefined period of time and in the **"RPM | RCF"** (A-1) display shows the lettering **"USEr Guide"**

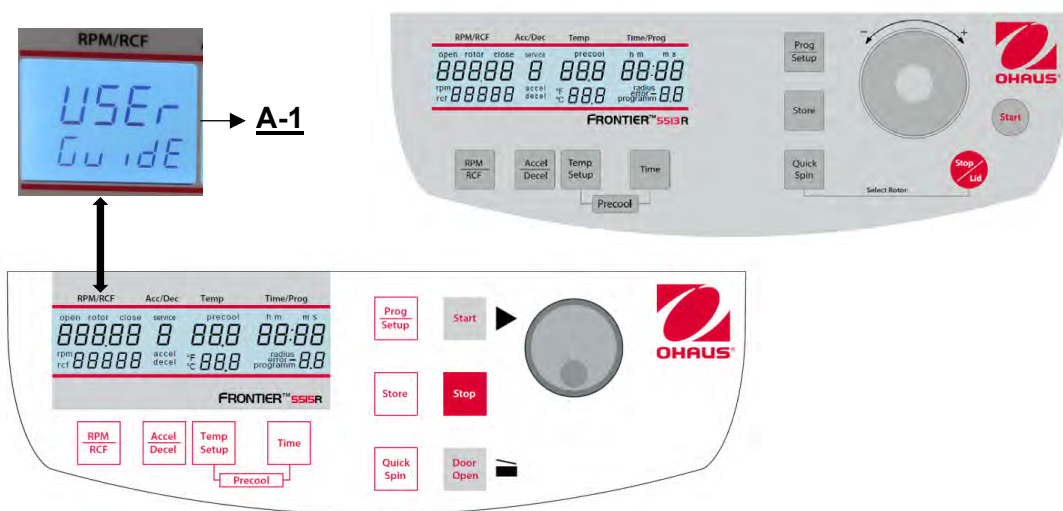

Figure 36

To reopen the centrifuge lid, switch off the device and wait until the rotor has come to a **standstill**. Take from **"Table 3: acceleration and deceleration times"** the maximum deceleration time of the respective rotor. Level 0 corresponds to unbroken rundown, which occurs at error 14. If the centrifuge lid is opened before standstill of the rotor, a following error can occur.

Once the rotor has come to a standstill, open the centrifuge lid with the emergency release. Proceed as described in chapter 6.2.1. After opening the centrifuge lid, switch on the device again. Error 14 and the lettering "USEr Guide" should be eliminated.

7 RECEIPT OF CENTRIFUGES TO REPAIR



ATTENTION!

Health risk from contaminated equipment, rotors, and accessories.

In case of returning the Centrifuge for repair, please take note of the following:

- The centrifuge **must** be decontaminated and cleaned before the shipment for the protection of persons, environment, and material.
- Decontamination certificate at goods return delivery (See APPENDIX). We reserve the right to not accept contaminated centrifuges.
- Further on all costs occurred for the cleaning and disinfection of the units will go to the debit of the customer's account.

8 TRANSPORT and STORAGE

8.1 Transport

- Before transporting, take out the rotor.
- Only transport the unit in the original packaging.
- Install the transport protection material to secure the motor shaft, when transporting over longer distances.

	Air temperature	Rel. humidity	Air pressure
General transportation	-25 to 60 °C	10 to 75 %	30 to 106 kPa

8.2 Storage

During storage of the centrifuge the following environmental conditions must be observed:

	Air temperature	Rel. humidity	Air pressure
In transportation packaging	-25 to 60 °C	10 to 75 %	30 to 106 kPa

9 TECHNICAL DATA

9.1 Specifications

9.1.1 Centrifuge FC5513L

Model	FC5513L, 230 V	FC5513L, 120 V
Order number	83041580	83041581
Speed Range	200 rpm - 14000 rpm; 10 rpm/set	
Maximum RCF	15994 x g; 10 x g/set	
Maximum Capacity (Rotor)	18x1.5/2.0 ml	
Temperature range (N/A)	Air cool	
Running Time	10 sec to 99 hr 59 min 59 sec or continuous	
Noise level (depending on the rotor)	≤ 57+2 dB(A)	
Allowable density at maximum speed	1.2 g/ml	
Allowable kinetic energy	1429 Nm	
Mains power connection AC	230 V~ 50/60 Hz	120 V~ 50/60 Hz
Voltage fluctuation	± 10 %	± 10 %
Current consumption	0.8 A	1.7 A
Power consumption	120 W	130 W
Dimensions (W × D × H)	277 x 351 x 231 mm 10.9 x 13.8 x 9.1 in	
Net Weight (without rotor)	13.5 kg 29.8 lb	
Shipping Dimensions (W × D × H)	370 x 460 x 360 mm 14.6 x 18.1 x 14.2 in	
Shipping Weight	15.5 kg 34.2 lb	
Environment	For indoor use only	
Altitude	Use up to an altitude of 2000 m	
Ambient temperature	5°C up to 35 °C	
Max. relative humidity	Max. relative humidity 80 % for temperatures up to 31°C, decreasing linearly to 50 % relative humidity up to 35°C.	
Overvoltage category (IEC 60364-4-443)	II	
Degree of contamination	2	
Class of protection	I	
Not suitable for use in hazardous environments.		
EMC	EN/IEC 61326-1 Class B emissions, Basic immunity FCC Class B emissions	

9.1.2 Centrifuge FC5513

Model	FC5513, 230 V	FC5513, 120 V
Order number	83041571	83041572
Speed Range	200 rpm - 13500 rpm; 10 rpm/set	
Maximum RCF	17317 x g; 10 x g/set	
Maximum Capacity (Rotor)	24x1.5/2.0 ml	
Temperature range (N/A)	Air cool	
Running Time	10 sec to 99 hr 59 min 59 sec or continuous	
Noise level (depending on the rotor)	≤ 60 ± 2 dB(A)	
Allowable density at maximum speed	1.2 g/ml	
Allowable kinetic energy	2129 Nm	
Mains power connection AC	230 V~ 50/60 Hz	120 V~ 50/60 Hz
Voltage fluctuation	± 10 %	± 10 %
Current consumption	1.05 A	1.9 A
Power consumption	170 W	170 W
Dimensions (W × D × H)	277 x 351 x 231 mm 10.9 x 13.8 x 9.1 in	
Net Weight (without rotor)	14 kg 30.9 lb	
Shipping Dimensions (W × D × H)	370 x 460 x 360 mm 14.6 x 18.1 x 14.2 in	
Shipping Weight (without rotor)	16 kg 35.3 lb	
Environment	For indoor use only	
Altitude	Use up to an altitude of 2000 m	
Ambient temperature	5°C up to 35 °C	
Max. relative humidity	Max. relative humidity 80 % for temperatures up to 31°C, decreasing linearly to 50 % relative humidity up to 35°C.	
Overvoltage category (IEC 60364-4-443)	II	
Degree of contamination	2	
Class of protection	I	
Not suitable for use in hazardous environments.		
EMC	EN/IEC 61326-1 Class B emissions, Basic immunity FCC Class B emissions	

9.1.3 Centrifuge FC5513R

Model	FC5513R, 230 V	FC5513R, 120 V
Order number	83041578	83041579
Speed Range	200 rpm - 14500 rpm; 10 rpm/set	
Maximum RCF	17157 x g; 10 x g/set	
Maximum Capacity (Rotor)	24x1.5/2.0 ml	
Temperature range	-20° to 40°C, 1°C/set	
Running Time	10 sec to 99 hr 59 min 59 sec or continuous	
Noise level (depending on the rotor)	≤ 56 ± 2 dB(A)	
Allowable density at maximum speed	1.2 g/ml	
Allowable kinetic energy	2266 Nm	
Mains power connection AC	230 V~ 50/60 Hz	120 V~ 50/60 Hz
Voltage fluctuation	± 10 %	± 10 %
Current consumption	1.05 A	1.9 A
Power consumption	170 W	170 W
Dimensions (W × D × H)	280 x 555 x 287 mm 11.0 x 21.9 x 11.3 in	
Net Weight (without rotor)	33 kg 73 lb	
Shipping Dimensions (W × D × H)	390 x 690 x 390 mm 15.4 x 27.2 x 15.4 in	
Shipping Weight (without rotor)	38 kg 83.5 lb	
Amount of refrigerant R290	33 g	
Environment	For indoor use only	
Min. room volume of location	4 m ³	
Altitude	Use up to an altitude of 2000 m	
Ambient temperature	5°C up to 35 °C	
Max. relative humidity	Max. relative humidity 80 % for temperatures up to 31°C, decreasing linearly to 50 % relative humidity up to 35°C.	
Overvoltage category (IEC 60364-4-443)	II	
Degree of contamination	2	
Class of protection	I	
Not suitable for use in hazardous environments.		
EMC	EN/IEC 61326-1 Class B emissions, Basic immunity FCC Class B emissions	

9.1.4 Centrifuge FC5515

Model	FC5515, 230 V	FC5515, 120 V
Order number	83041547	83041548
Speed Range	200 rpm - 15200 rpm; 10 rpm/set	
Maximum RCF	21953 x g; 10 x g/set	
Maximum Capacity (Rotor)	44x1.5/2.0 ml	
Temperature range (N/A)	Air cool	
Running Time	10 sec to 99 hr 59 min 59 sec or continuous	
Noise level (depending on the rotor)	≤ 60 ± 2 dB(A)	
Allowable density at maximum speed	1.2 g/ml	
Allowable kinetic energy	7204 Nm	
Mains power connection AC	230 V~ 50/60 Hz	120 V~ 50/60 Hz
Voltage fluctuation	± 10 %	± 10 %
Current consumption	1.3 A	2.3 A
Power consumption	270 W	280 W
Dimensions (W × D × H)	280 x 393 x 287 mm 11.0 x 15.5 x 11.3 in	
Net Weight (without rotor)	20 kg 44 lb	
Shipping Dimensions (W × D × H)	410 x 540 x 400 mm 16.1 x 12.3 x 15.7 in	
Shipping Weight (without rotor)	16 kg 35.3 lb	
Environment	For indoor use only	
Altitude	Use up to an altitude of 2000 m	
Ambient temperature	5°C up to 35 °C	
Max. relative humidity	Max. relative humidity 80 % for temperatures up to 31°C, decreasing linearly to 50 % relative humidity up to 35°C.	
Overvoltage category (IEC 60364-4-443)	II	
Degree of contamination	2	
Class of protection	I	
Not suitable for use in hazardous environments.		
EMC	EN/IEC 61326-1 Class B emissions, Basic immunity FCC Class B emissions	

9.1.5 Centrifuge FC5515R

Model	FC5515R, 230 V	FC5515R, 120 V
Order number	83041549	83041550
Speed Range	200 rpm - 14500 rpm; 10 rpm/set	
Maximum RCF	21953 x g; 10 x g/set	
Maximum Capacity (Rotor)	24x1.5/2.0 ml	
Temperature range	-20° to 40°C, 1°C/set	
Running Time	10 sec to 99 hr 59 min 59 sec or continuous	
Noise level (depending on the rotor)	≤ 57 ± 2 dB(A)	
Allowable density at maximum speed	1.2 g/ml	
Allowable kinetic energy	7204 Nm	
Mains power connection AC	230 V~ 50/60 Hz	120 V~ 50/60 Hz
Voltage fluctuation	± 10 %	± 10 %
Current consumption	2.4 A	5.1 A
Power consumption	500 W	560 W
Dimensions (W × D × H)	280 x 555 x 287 mm 11.0 x 21.9 x 11.3 in	
Net Weight (without rotor)	35 kg 77 lb	
Shipping Dimensions (W × D × H)	390 x 690 x 390 mm 15.4 x 27.2 x 15.4 in	
Shipping Weight (without rotor)	44 kg 97 lb	
Amount of refrigerant R290	38 g	
Environment	For indoor use only	
Room volume of location	4.5 m ³	
Altitude	Use up to an altitude of 2000 m	
Ambient temperature	5°C up to 35 °C	
Max. relative humidity	Max. relative humidity 80 % for temperatures up to 31°C, decreasing linearly to 50 % relative humidity up to 35°C.	
Overvoltage category (IEC 60364-4-443)	II	
Degree of contamination	2	
Class of protection	I	
Not suitable for use in hazardous environments.		
EMC	EN/IEC 61326-1 Class B emissions, Basic immunity FCC Class B emissions	

9.2 Drawings and dimension

Dimensions for FC5513L and FC5513

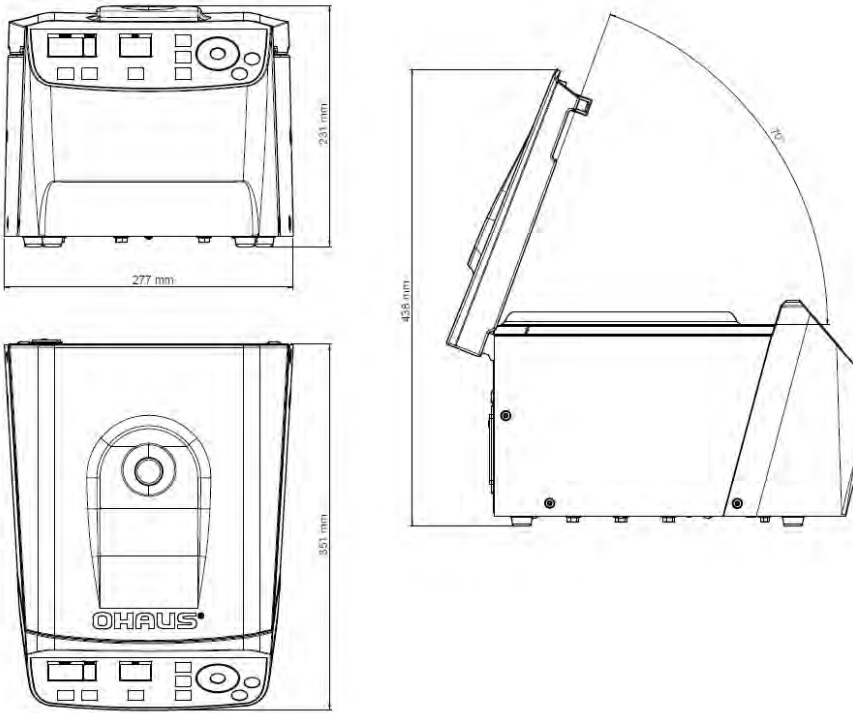

Dimensions for FC5515

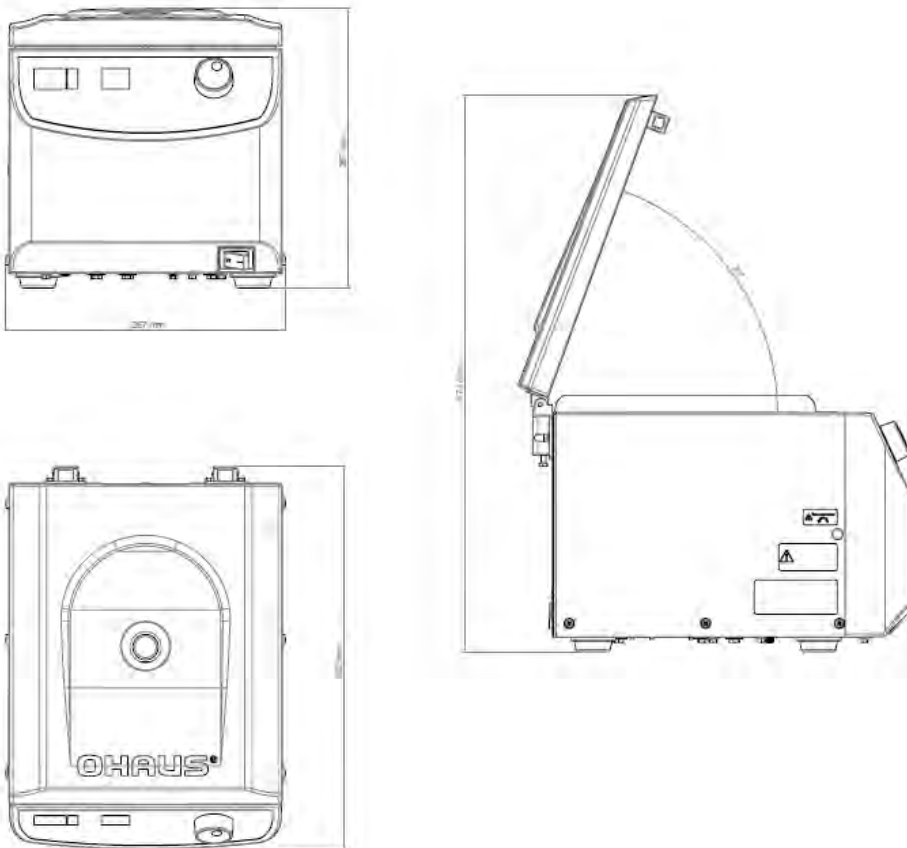

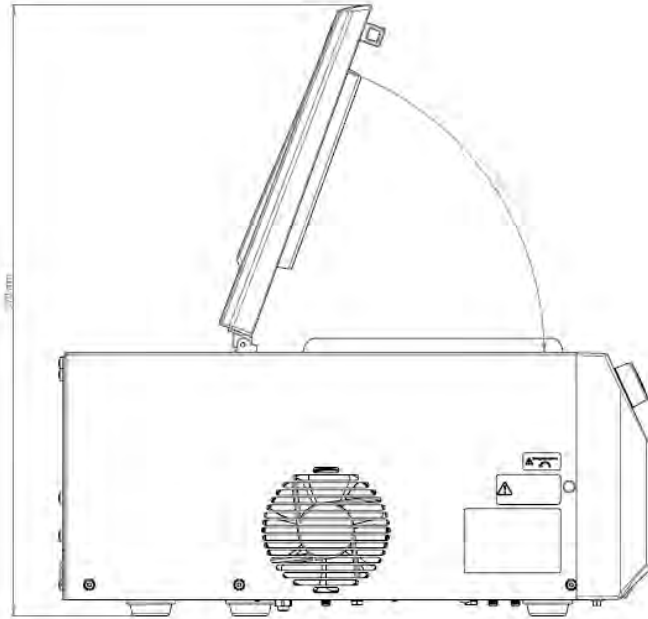
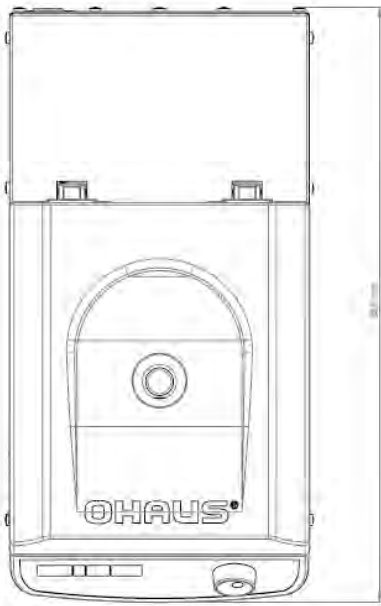
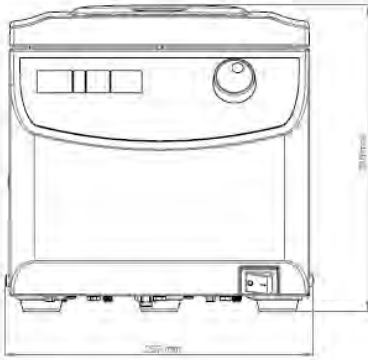

Dimensions for FC5515R and FC5513R



10 COMPLIANCE

Compliance to the following standards is indicated by the corresponding mark on the product.

	The EU Declaration of Conformity is available online.
---	---

	<p>Disposal</p> <p>In conformance with the European Directive 2012/19/EU on Waste Electrical and Electronic Equipment (WEEE) this device may not be disposed of in domestic waste. This also applies to countries outside the EU, per their specific requirements.</p> <p>Please dispose of this product in accordance with local regulations at the collecting point specified for electrical and electronic equipment.</p> <p>If you have any questions, please contact the responsible authority or the distributor from which you purchased this device.</p> <p>Should this device be passed on to other parties (for private or professional use), the content of this regulation must also be related.</p> <p>For disposal instructions in Europe, refer to the OHAUS website. Thank you for your contribution to environmental protection.</p>
---	--

11 APPENDIX

TABLE 1: PERMISSIBLE NET WEIGHT

TABLE 2: MAX. SPEED AND RCF-VALUES FOR PERMISSIBLE ROTORS

TABLE 3: ACCELERATION AND DECELERATION TIMES

TABLE 4: LOWEST TEMPERATURE AT MAX SPEED WITH REFRIGERATED MODELS

TABLE 5: ERROR MESSAGES

TABLE 6: RADIUS CORRECTION

TABLE 7: TABLE OF THE SERVICE LIFE OF ROTORS

TABLE 8: REDEMPTION FORM / DECONTAMINATION CERTIFICATE

11.1 Table 1: Permissible net weight

Rotor ID	Order No.	Description	Max. speed	Permissible weight
07	83041007	Rotor Hematocrit 24xCapillaries V2	13000 rpm	4.8 g
17	30372717	Rotor Angle 44x1.5/2.0ml V1	15000 rpm	165 g
50	83041050	Rotor Angle 24x2.0ml Spin Column V1	13500 rpm	82 g
71	30642371	Rotor Angle 24x1.5/2.0ml BIOSEALS V2	15200 rpm	82 g
72	30130872	Rotor Angle 30x1.5/2.0ml	13500 rpm	102 g
73	30130873	Rotor Angle 12x5ml FA	14500 rpm	114 g
74	30130874	Rotor Angle 4x8-Place PCR Strip	15000 rpm	14 g
02	30472302	Rotor Angle 24x1.5/2.0ml BIOSEALS V1	13500 rpm	82 g
04	30472304	Rotor Hematocrit 24xCapillaries V1	13000 rpm	4.8 g
06	83041006	Rotor Angle 18x1.5/2.0ml	14500 rpm	62 g
14	83041014	Rotor Angle 4x8-w PCR Strip V1	13500 rpm	14 g
98	30210898	Rotor Angle 24x2.0ml Spin Column	13500 rpm	82 g

11.2 Table 2: Max. speed and RCF-values for permissible rotors

Rotor ID	Order No.	Description	Used in model	Max Speed	Max RCF
07	83041007	Rotor Hematocrit 24xCapillaries V2	FC5515/R	13000 rpm	16058 x g
17	30372717	Rotor Angle 44x1.5/2.0ml V1	FC5515/R	15000 rpm	21127 x g / 21379 x g
50	83041050	Rotor Angle 24x2.0ml Spin Column V1	FC5515/R	13500 rpm	17317 x g
71	30642371	Rotor Angle 24x1.5/2.0ml BIOSEALS V2	FC5515/R	15200 rpm	21953 x g
72	30130872	Rotor Angle 30x1.5/2.0ml	FC5515/R	13500 rpm	19151 x g
73	30130873	Rotor Angle 12x5ml FA	FC5515/R	14500 rpm	19978 x g
74	30130874	Rotor Angle 4x8-Place PCR Strip	FC5515/R	15000 rpm	15343 x g
02	30472302	Rotor Angle 24x1.5/2.0ml BIOSEALS V1	FC5513	13500 rpm	17317 x g
			FC5513R	13000 rpm	16058 x g
04	30472304	Rotor Hematocrit 24xCapillaries V1	FC5513	13000 rpm	16058 x g
06	83041006	Rotor Angle 18x1.5/2.0ml	FC5513R	14500 rpm	17157 x g
			FC5513L	14000 rpm	15994 x g
14	83041014	Rotor Angle 4x8-w PCR Strip V1	FC5513	13500 rpm	14669 x g
			FC5513R	13000 rpm	13602 x g
98	30210898	Rotor Angle 24x2.0ml Spin Column	FC5513	13500 rpm	17317 x g

11.3 Table 3: Acceleration and deceleration times

FC5515

Rotor ID	Order No.	Rotor Type	Acceleration Time in seconds		Deceleration Time in seconds	
			level 0	level 9	level 0	level 9
07	83041007	Rotor Hematocrit 24 x Capillaries V2	89	11	106	9
17	30372717	Rotor Angle 44 x 1.5/2.0 ml V1	259	35	188	18
50	83041050	Rotor Angle 24 x 2.0ml Spin Column V1	136	16	88	12
71	30642371	Rotor Angle 24 x 1.5/2.0 ml BIOSEALS V2	152	21	173	18
72	30130872	Rotor Angle 30 x 1.5/2.0 ml	237	29	258	27
73	30130873	Rotor Angle 12 x 5 ml FA	146	23	320	16
74	30130874	Rotor Angle 4 x 8-Place PCR Stripes	149	17	94	19
			Acceleration time from 0 min ⁻¹ -> U _{max}		Deceleration time from U _{max} -> 0 min ⁻¹	

FC5515R

Rotor ID	Order No.	Rotor Type	Acceleration Time in seconds		Deceleration Time in seconds	
			level 0	level 9	level 0	level 9
17	30372717	Rotor Angle 44 x 1.5/2.0 ml V1	265	32	258	18
50	83041050	Rotor Angle 24 x 2.0 ml Spin Column V1	137	16	138	11
71	30642371	Rotor Angle 24 x 1.5/2.0 ml BIOSEALS V2	153	20	250	17
72	30130872	Rotor Angle 30 x 1.5/2.0 ml	231	27	314	26
73	30130873	Rotor Angle 12 x 5 ml FA	146	23	318	16
74	30130874	Rotor Angle 4 x 8-Place PCR Strip	147	17	111	17
			Acceleration time from 0 min ⁻¹ -> U _{max}		Deceleration time from U _{max} -> 0 min ⁻¹	

FC5513

Rotor ID	Order No.	Rotor Type	Acceleration Time in seconds		Deceleration Time in seconds	
			Stage 0	Stage 9	Stage 0	Stage 9
02	30472302	Rotor Angle 24 x 1.5/2.0 ml BIOSEALS V1	108	15	116	13
04	30472304	Rotor Hematocrit 24 x Capillaries V1	156	20	160	22
14	83041014	Rotor Angle 4 x 8-w PCR Strip V1	108	15	116	14
98	30210898	Rotor Angle 24 x 2.0 ml Spin Column	136	19	171	18
			Acceleration time from 0 min ⁻¹ -> U _{max}		Deceleration time from U _{max} -> 0 min ⁻¹	

FC5513R

Rotor ID	Order No.	Rotor Type	Acceleration Time in seconds		Deceleration Time in seconds	
			Stage 0	Stage 9	Stage 0	Stage 9
02	30472302	Rotor Angle 24 x 1.5/2.0 ml BIOSEALS V1	212	26	227	24
06	83041006	Rotor Angle 18 x 1.5/2.0 ml	121	18	151	17
14	83041014	Rotor Angle 4 x 8-w PCR Strip V1	212	26	227	24
			Acceleration time from 0 min ⁻¹ -> U _{max}		Deceleration time from U _{max} -> 0 min ⁻¹	

FC5513L

Rotor ID	Order No.	Rotor Type	Acceleration Time in seconds		Deceleration Time in seconds	
			Stage 0	Stage 9	Stage 0	Stage 9
06	83041006	Rotor Angle 18 x 1.5/2.0 ml	122	14	140	16
			Acceleration time from 0 min ⁻¹ -> U _{max}		Deceleration time from U _{max} -> 0 min ⁻¹	

11.4 Table 4: Lowest temperature at max. speed in refrigerated models

Rotor ID	Order No.	Description	Used in model	Max. speed	n-max
07	83041007	Rotor Hematocrit 24 x Capillaries V2	FC5515R	13000 rpm	N/A
17	30372717	Rotor Angle 44 x 1.5/2.0 ml V1	FC5515R	15000 rpm	10°C
50	83041050	Rotor Angle 24 x 2.0 ml Spin Column V1	FC5515R	13500 rpm	9°C
71	30642371	Rotor Angle 24 x 1.5/2.0 ml BIOSEALS V2	FC5515R	15000 rpm	6°C
72	30130872	Rotor Angle 30 x 1.5/2.0ml	FC5515R	13500 rpm	9°C
73	30130873	Rotor Angle 12 x 5ml FA	FC5515R	14500 rpm	7°C
74	30130874	Rotor Angle 4 x 8-Place PCR Strip	FC5515R	15000 rpm	6°C
02	30472302	Rotor Angle 24 x 1.5/2.0 ml BIOSEALS V1	FC5513R	13000 rpm	0°C
06	83041006	Rotor Angle 18 x 1.5/2.0 ml	FC5513R	14500 rpm	0°C
14	83041014	Rotor Angle 4 x 8-w PCR Strip V1	FC5513R	13000 rpm	0°C

11.5 Table 5: Error messages

Error-No.	Description
1	Imbalance arose
2	Imbalance sensor is defective
4	Imbalance switch has been activated for longer than 5 seconds
8	Transponder in the rotor is defective
11	Temperature sensor defective (only FC5513R)
12	Chamber over temperature (only FC5513R)
14	Leap of speed is too big between two measurements
CLOSE lid	
15	Standstill monitoring defective
16	Wrong direction of rotation of the motor
18	Unit too warm
19	Drive overloaded, check if correct rotor is set
33	Open lid while motor is running
34	Lid contact defective
38	Lid motor is blocked
40	Communication with frequency converter disturbed during start
41	Communication with frequency converter disturbed during stop
42	Short circuit in the frequency converter
43	Undervoltage intermediate circuit voltage
44	Overvoltage intermediate circuit voltage
45	Over temperature frequency converter
47	Overvoltage Motor
48	Timeout between control unit and frequency converter
49	Other error frequency converter
55	Overspeed
70	Timeout between controller and interface
80	Memory Error intern EEPROM
81	Memory failure
99	Rotor is not allowed for this program
FALSE	Inserted rotor does not exist in the program

11.6 Table 6: Radius correction and adapter specifications

Rotor Order No.	Description	Adapter Order No.	Radius (cm)	Correction (cm)
30372717	Rotor Angle 44 x 1.5/2.0 ml V1	None	8.5	0
		30130885	8.3	-0.2
		30130884	7.7	-0.8
30642371	Rotor Angle 24 x 1.5/2.0 ml BIOSEALS V2	None	8.5	0
		30130885	8.2	-0.3
		30130884	7.5	-1.1
30130872	Rotor Angle 30 x 1.5/2.0 ml	None	9.4	0
		30130885	9.1	-0.3
		30130884	8.4	-1.1
30130873	Rotor Angle 12 x 5 ml FA	None	8.5	0
		30130886	7.0	-1.5
		30130887	7.3	-1.2
		30130888	7.5	-1.0
30472302	Rotor Angle 24 x 1.5/2.0 ml BIOSEALS V1	None	8.5	0.0
		30130885	8.2	-0.3
		30130884	7.5	-1.0
83041006	Rotor Angle 18 x 1.5/2.0 ml	None	7.3	0.0
		30130885	7.0	-0.3
		30130884	6.3	-1.0

11.7 Table 7: Table of the service life of the rotors

Rotor ID	Order No.	Description	Service life, years
07	83041007	Rotor Hematocrit 24 x Capillaries V2	7
17	30372717	Rotor Angle 44 x 1.5/2.0 ml V1	7
50	83041050	Rotor Angle 24 × 2.0 ml Spin Column V1	3
71	30642371	Rotor Angle 24 x 1.5/2.0 ml BIOSEALS V2	7
72	30130872	Rotor Angle 30 x 1.5/2.0 ml	7
73	30130873	Rotor Angle 12 x 5 ml FA	7
74	30130874	Rotor Angle 4 x 8-Place PCR Strip	3
02	30472302	Rotor Angle 24 × 1.5/2.0 ml BIOSEALS V1	3
04	30472304	Rotor Hematocrit 24 x Capillaries V1	7
06	83041006	Rotor Angle 18 x 1.5/2.0 ml	3
14	83041014	Rotor Angle 4 x 8-w PCR Strip V1	3
98	30210898	Rotor Angle 24 × 2.0 ml Spin Column	3

11.8 Redemption form / Decontamination certificate

Enclose this form with all returns of equipment and assemblies!

The completed declaration about the decontamination is a prerequisite for the assumption and further processing of the return. If no corresponding explanation is enclosed, we carry out decontamination with costs at your expense.

Surname:

First name:

Organization / company:

Street:

Zip code:

Telephone:

fax:

E-Mail:

Please fill out in block capitals!

Pos.	Crowd	Decontaminated object	Serial number	Description /Comment
1				
2				
3				
4				

Are the parts listed above in contact with the following substances?

- 1. Health endangering watery solutions, buffers, acids, alkalis Yes No
- 2. Potentially infectious agents Yes No
- 3. Organic reagents and solvent Yes No
- 4. Radioactive substances α β γ Yes No
- 5. Health endangering proteins Yes No
- 6. DNA Yes No
- 7. These substances have reached the equipment/assembly? Yes No
 Which one, if yes:

Description of the measures for the decontamination of the listed parts:

I confirm the proper decontamination:

Company/Department:

Place and Date:

Signature of responsible person: