

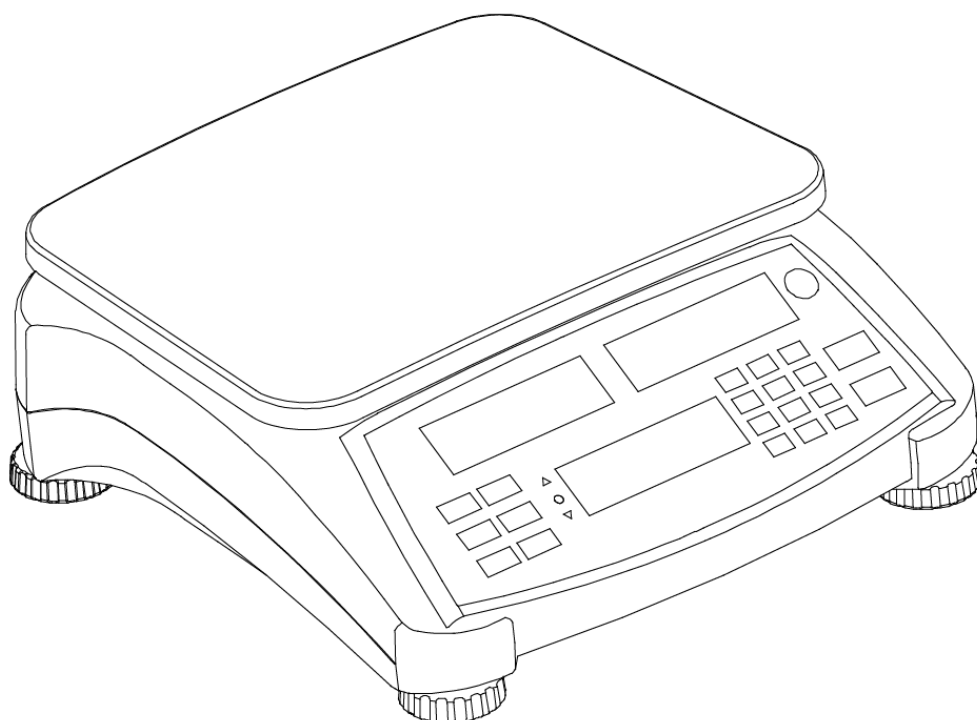

Ranger™ 4000 Count Series Instruction Manual



1. INTRODUCTION

This manual contains installation, operation and maintenance instructions for the Ranger™ Count 4000 Series. Please read the manual completely before using the scale.

1.1 Definition of Signal Warnings and Symbols

Safety notes are marked with signal words and warning symbols. These show safety issues and warnings. Ignoring the safety notes may lead to personal injury, damage to the instrument, malfunctions and false results.

Signal Words

- WARNING** For a hazardous situation with medium risk, possibly resulting in injuries or death if not avoided.
- CAUTION** for a hazardous situation with low risk, resulting in damage to the device or the property or in loss of data, or injuries if not avoided.
- Note** (No symbol)
For useful information about the product

Warning Symbols



General Hazard



Electrical Shock Hazard



Alternating Current

1.2 Safety Precautions

Please follow these safety precautions:

- Verify that the AC input voltage printed on the data label matches the local AC power supply.
- Only connect the power cord to a compatible grounded electrical outlet.
- Do not position the scale such that it is difficult to disconnect the power cord from the power receptacle.
- This scale is for indoor use only.
- Use the scale in dry locations only.
- Do not drop loads on the platform.
- Make sure that the power cord does not pose a potential obstacle or tripping hazard.
- Use only approved accessories and peripherals.
- Operate the scale only under ambient conditions specified in these instructions.
- Disconnect the scale from the power supply when cleaning.
- Do not operate the scale in hazardous or unstable environments.
- Do not immerse the scale in water or other liquids.
- Do not place the scale upside down on the platform.
- Only use weights within the scale's capacity as specified in these instructions.
- Service should be performed only by authorized personnel.

2. INSTALLATION

2.1 Package Contents

- Scale
- Pan
- Power Cord
- Sub-platform
- Instruction Manual / CD
- Warranty Card

2.2 Installing Components

Install the sub-platform & metal pan as shown below. Press to lock the sub-platform into place. The scale can be operated without the pan, if desired.

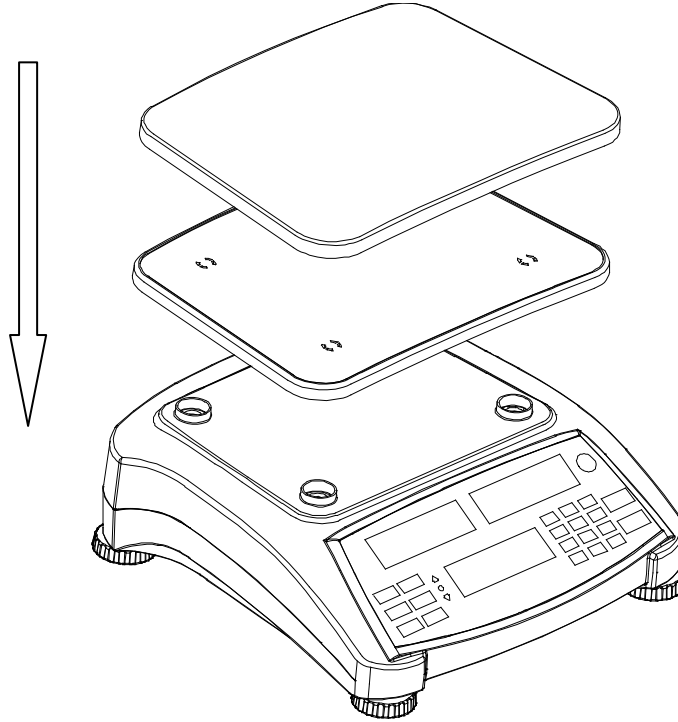

Figure 2-1. Installing sub-platform and metal pan

2.3 Selecting the Location

Use the scale on a firm, steady surface. Avoid locations with excessive air current, vibrations, heat sources, or rapid temperature changes. Allow sufficient space around the scale.

2.4 Leveling the Equipment

The Ranger Count Series has a level indicator as a reminder that the scale should be leveled for accurate weighing. To level the scale, adjust the feet so the bubble is centered in the circle. Be sure the equipment is level each time its location is changed.

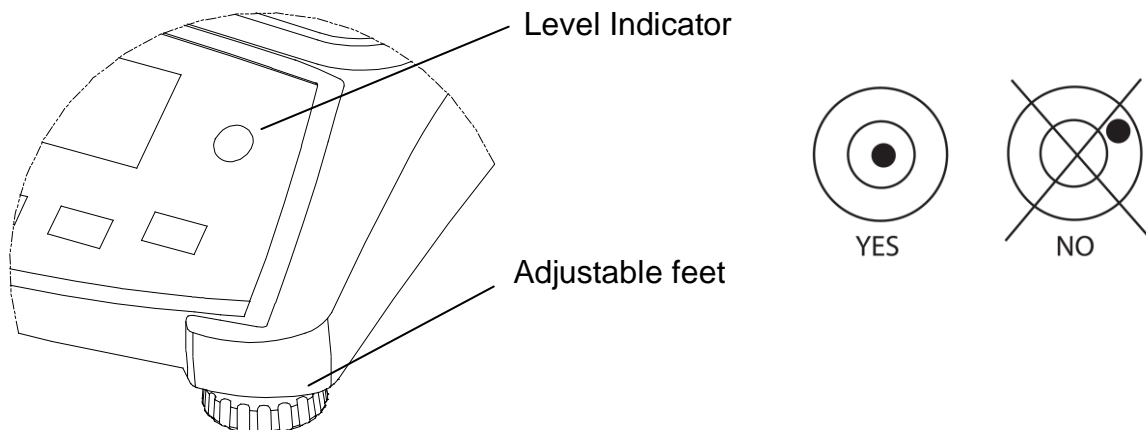

Figure 2-2. Level indicator

2.5 Connecting Power

AC power is used to power the scale when battery power is not needed. First, connect the AC power cord (supplied) to the power input receptacle then connect the AC plug to an electrical outlet.

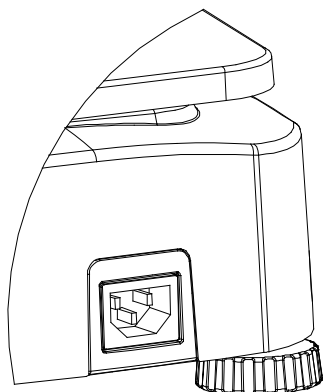

Figure 2-3A. Connect the AC power plug to the input receptacle on the back of scale.

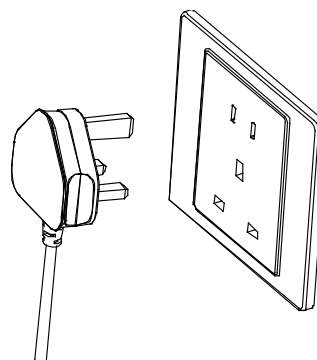

Figure 2-3B. Connect the AC power plug to the proper AC supply.





2.5.1 Battery Power:

The scale can be used on AC power immediately. Allow the battery to charge for 12 hours before using the scale on battery power. The scale will automatically switch to battery operation if there is a power failure or the power cord is removed. With AC power, the scale is constantly charging, so the battery charge indicator (see item 10 in figure 3-2) will remain lit. The scale can be operated during charging, and the battery is protected against overcharging.

During battery operation, the battery symbol indicates the battery charge level. The scale will automatically turn off when the batteries are fully discharged.

For maximum operating time, the battery should be charged at room temperature.

TABLE 2-1

Symbol	Charge Level
	0 to 10 % Remaining
	11 to 40 % Remaining
	41 to 70 % Remaining
	71 to 100 % Remaining

Notes:

When battery symbol blinks fast, approximately 30 minutes working time is left.

When [lo.bat] is displayed, the scale will shut off.

Charging the scale must be performed in a dry environment.



CAUTION: Battery is to be replaced only by an authorized Ohaus service dealer. Risk of explosion can occur if the rechargeable battery is replaced with the wrong type or if it is not properly connected. Dispose of the lead acid battery according to local laws and regulations.

3. OPERATION

3.1 Displays

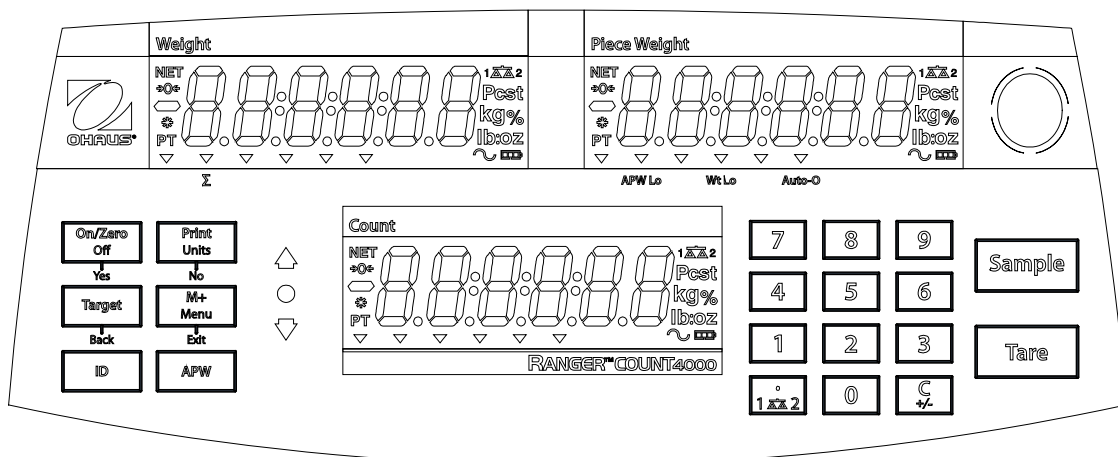
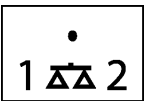
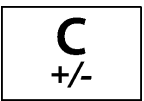



Figure 3-1. Ranger Count 4000 Control panel with LCD displays

TABLE 3-1. Control Functions

Button	On/Zero Off Yes	Print Units No	Target Back	M+ Menu Exit	ID	APW
Primary Function (Short Press ¹)	ON/ZERO Turn scale on. Zero the display.	PRINT Send the displayed value to the COM port.	Target Initiate the function of the current application mode.	M+ Accumulate the weight or pieces.	ID ID number input for library record edit/recall.	APW Display/Store an APW
Secondary Function (Long Press ²)	Off Turn scale off.	Units Change the weighing unit.	Switch between Check Weigh, Check Count and Off.	Menu Enter user menu. View the Audit Trail event counters (extended press)		
Menu Function (Short Press)	Yes Accept the current menu or setting.	No Advance to the next menu or setting. Increment the displayed value.	Back Go back to the previous menu or setting. Decrement the displayed value.	Exit Exit the menu. Abort the calibration in progress.		
Library Function (Short Press)	Yes Accept the current setting.	No Advance to the next library or setting. Increment the displayed value.	Back Go back to the previous library or setting. Decrement the displayed value.	Exit Exit the library.		

TABLE 3-1. Cont.

Button	<table border="1"> <tr><td>7</td><td>8</td><td>9</td></tr> <tr><td>4</td><td>5</td><td>6</td></tr> <tr><td>1</td><td>2</td><td>3</td></tr> <tr><td>0</td><td></td><td></td></tr> </table>	7	8	9	4	5	6	1	2	3	0						
7	8	9															
4	5	6															
1	2	3															
0																	
Primary Function (Short Press)	0-9 Enter numeric values on the display.	• Enter dot (.) on the display.	C Clear the last character from the display.	Tare Perform a tare operation.	Sample Display/ Start new APW												
Secondary Function (Long Press)		1 ΔΔ 2 Switch between scale 1 and scale 2 (only available if second platform is connected)	+/- Switch between positive and negative value														

Notes: ¹ Short Press: Press less than 1 second.
² Long Press: Press and hold for more than 2 seconds.

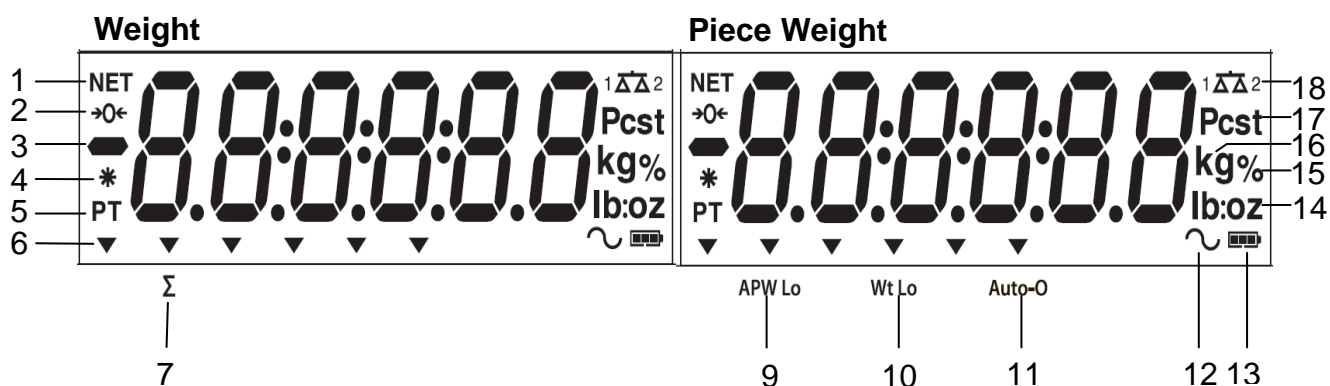

Figure 3-2. LCD Displays

TABLE 3-2. LCD Symbols

Item	Description	Item	Description
1	NET symbol	10	Low Sample Weight Symbol
2	Center of Zero symbol	11	Auto Optimization Symbol
3	Negative symbol	12	Dynamic symbol (not used)
4	Stable weight symbol	13	Battery charge symbol
5	Preset Tare, Tare symbols	14	Pound, Ounce, Pound:Ounce symbols
6	Pointer symbols	15	Percent symbol (not used)
7	Accumulation symbol	16	Kilogram, gram symbols
8		17	Pieces symbol, tonne symbol (not used)
9	Low Average Piece Weight Symbol	18	Scale symbol (only shown when 2 nd platform is connected and turned on)

The colored LED indicators on the left side of the control panel are used in Checkweigh mode (section 3.7) and will light up according to the following rules:

- △ (Red) Loads > Upper limit
- (Green) Loads Lower limit and Upper limit
- ▽ (Yellow) Loads < Lower limit

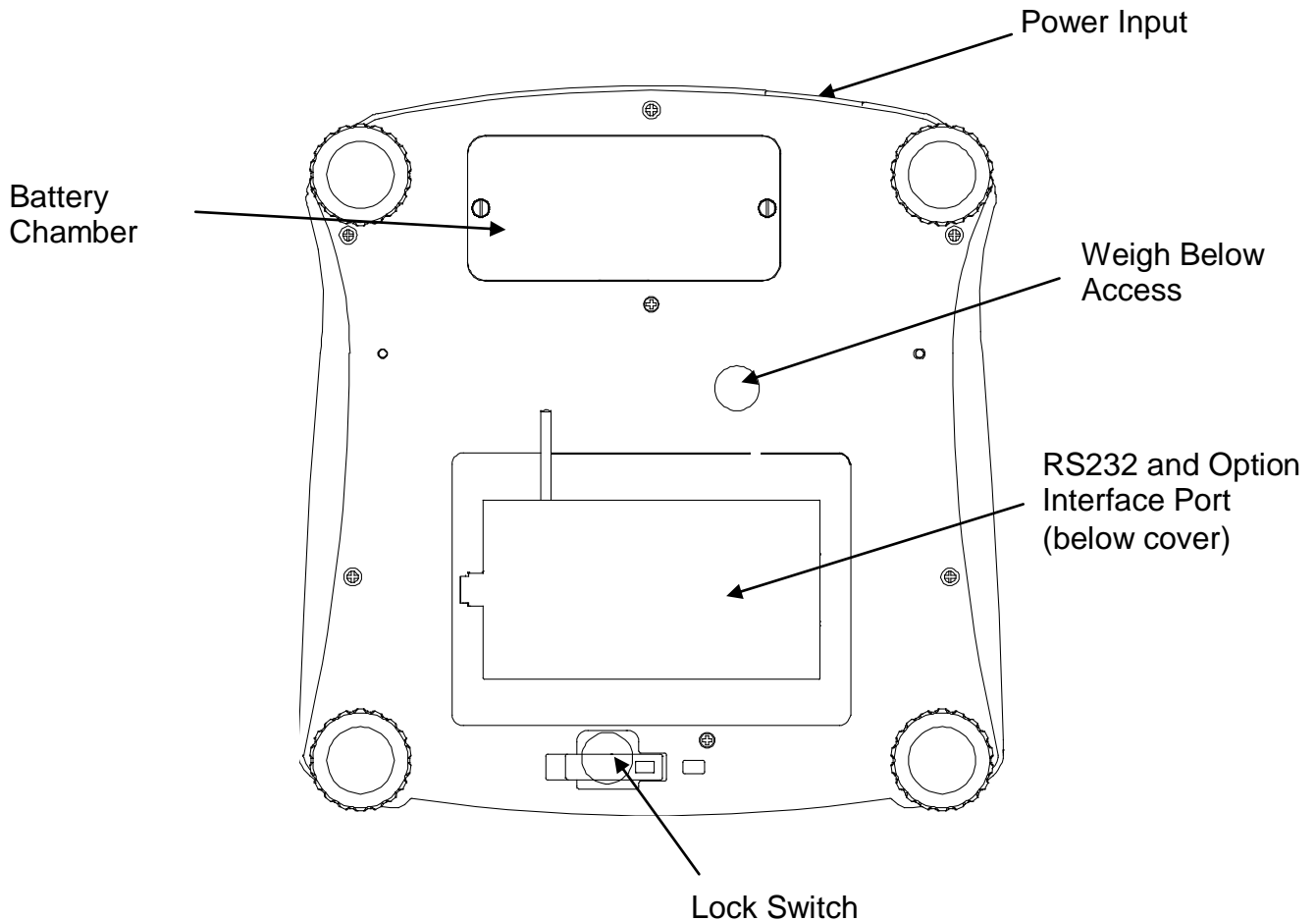

Figure 3-3. Below view of Ranger Count 4000

3.2 Turning Scale On/Off

To turn the scale on, press and hold the **On/Zero Off** button for 1 second. The scale performs a display test, momentarily displays the software version, and then enters the active weighing mode.

To turn the scale off, press and hold the **On/Zero Off** button until OFF is displayed.

3.3 Counting

Ranger Count 4000 has three display areas. Weight, Piece Weight and Count information are displayed in these areas respectively.

3.3.1 Preset tare

Enter a value with the numeric keypad. The value will be displayed in the Count window. Pressing Tare key, the value in current unit will then be saved as the preset tare. To clear the tare value, clear the pan and press **Tare** key.

3.3.2 APW Establishment

If there is no APW established, both the piece weight display and the count display will show 0.

Positive Sampling:

1. Place the sample on the pan.
2. Input the sample size with the numeric keypad. The value is displayed in the count window.

Alternatively the **Sample** key can be used instead. Pressing the **Sample** key and [—] is displayed in the count window. Then input the sample size value (only integer).

3. Press the **Sample** key, [—] will be displayed in both the piece window and the count window.
4. The established APW and count will be displayed.

Negative sampling:

1. Place container with the samples on the pan.
2. Tare the scale, a NET 0 will be displayed.
3. Remove the samples from the container; weight window will now display a negative net reading.
4. Input the sample size with the numeric keypad. The value will be displayed in the count window.

Alternatively the **Sample** key can be used instead. Pressing the **Sample** key and [-] is displayed in the count window. Then input the sample size value (only integer).

5. Press the **Sample** key, [-] will be displayed in both the piece window and the count window.
6. The established APW and count will be displayed.

Entering a known APW:

1. Press the APW key, [—] will be displayed in the piece window
2. Input the APW value.
3. Press the APW key, the new APW value will be displayed in piece weight window.

3.3.3 Simple Counting

1. After a valid APW is established, if required place a container on the pan and press **Tare**.
2. Place the sample on the pan.
3. The quantity will be displayed in the count window.

3.4 Accumulation and Statistics

The Accumulation feature enables manual or automatic totalizing of displayed values. Statistical data is stored in memory for review and printing. Accumulation works together with Check mode.

3.4.1 Accumulating Displayed Values

With ACCUMULATE set to MANUAL, place the item on the scale and press the **M+** key to add the weight to accumulation data. The icon will keep flashing until the weight is removed. With ACCUMULATE set to AUTO, place the item on the scale. The displayed value is accumulated automatically. The icon will keep flashing until the weight is removed.

3.4.2 Viewing and Clearing Statistical Data

When the pan is cleared, press the **M+** key to display the statistical information. To clear the accumulation data press the **Tare** key while the statistical information is displayed. The display shows [Clr.aCC]. Press the **Yes** key to clear the stored data and return to current mode.

Notes: The item must be removed from the pan before the next item can be accumulated.
Only stable weights are stored to accumulation data.
Changing the mode will clear the accumulation data.

3.5 Check-Weighing

Press and hold the **Target** key, [Check] is displayed in the weight window. Release the **Target** key when [wWeIGH] is displayed in the piece weight window. Use this mode to compare the weight of items to a target weight range.

1. Press the **Target** key, [Under] is displayed in the weight screen. The previous under limit will be displayed in the piece weight screen.
2. Input the target weight with the numeric keypad. The value will be displayed in the count window.
3. Press the **Yes** key to accept the under limit value, [Over] is displayed in the weight screen.
4. Repeat step 2 and 3 above to set the over limit.
5. If required, place an empty container on the pan and press **Tare**.
6. Place sample material on the pan or in the container. If the sample weight is under the target weight range, the yellow LED will light. If the sample is within the target weight range, the green LED will light. If the sample is over the target weight range, the red LED will light.

3.6 Check-Counting

Press and hold the **Target** key, [Check] is displayed in the weight window. Release the **Target** key when [Count] is displayed in the piece weight window.

1. Press the **Target** key, [Under] is displayed in the weight screen. The previous under limit will be displayed in the piece weight screen.
2. Input the sample size with the numeric keypad. The value will be displayed in the count window.
3. Press the **Yes** key to accept the under limit value, [Over] is displayed in the weight screen.
4. Repeat step 2 and 3 above to set the over limit.
5. If required, place an empty container on the pan and press **Tare**.
6. Place sample material on the pan or in the container. If the sample quantity is under the target pieces range, the yellow LED will light. If the sample is within the target pieces range, the green LED will light. If the sample is over the target pieces range, the red LED will light.

Positive Check

Positive check is used to determine when the material added to the scale is within the target range. In this case the UNDER and OVER limits must be positive values. (The OVER limit must be greater than the UNDER limit.)

Add material to the scale until it is within the ACCEPT (green) range.

Negative Check

Negative check is used to determine when the material removed from the scale is within the target range. In this case the UNDER and OVER limits are both negative values.

(The UNDER limit must be greater than the OVER limit.)

Place the item to be weighed on the scale and press **Tare**.

Remove a portion of the item until it is within the ACCEPT range.

Zero Check

Zero check is used when comparing subsequent samples to an initial reference sample. In this case, the UNDER limit must be a negative value and the OVER limit must be a positive value.

Place the reference item on the scale and press **Tare**. Remove the reference sample and place the item to be compared on the scale to determine if it is within the ACCEPT range.

3.7 Library

When an item is processed on a regular basis, the item's data may be stored in memory for future use. This memory is referred to as the scale's Library.

Storing a record:

1. Press the **ID** key, [Store] and [lib] are displayed in the weight and piece weight windows respectively. The first vacant ID number will blink in the count window.
2. Press **ID** key to save the data to the displayed ID number. Alternately, a different ID number may be selected using the keypad and then pressing the **ID** key.

Note: Maximum 30 records, from 0 to 29.

Retrieving a record:

1. Enter the ID number using the keypad and press the **ID** key. [reCall] and [lib] are displayed in the weight and piece weight windows respectively.
2. ID number is displayed in the weight window.
3. Press the **ID** or **Yes** key, [reCall] is displayed and the data is retrieved.

Editing a record:

1. Enter the ID number using the keypad and press the **ID** key. [reCall] and [lib] are displayed in the weight and piece weight windows respectively.
2. Long press the **ID** key, [edit] and [lib] are momentarily displayed in the weight and piece weight windows respectively.
3. Part number is displayed in the weight and piece weight windows. Default setting is [000000] [000000]. Use the keypad to enter part number if required.
4. Press the **Yes** key to save the part number and advance to the preset Tare setting. Use the keypad to enter a preset Tare value if required.
5. Press the **Yes** key to save the preset Tare value and advance to the APW setting. Use the keypad to enter a new APW value if required.
6. Press the **Yes** key to save the APW and advance to the Limits setting. Use the keypad to enter new under and over limits if required.
7. Press the **Yes** key to save the limits. [save] is displayed in the weight window. Press the **Yes** key to save the data.

Clearing a record:

1. Enter the ID number using the keypad and press the **ID** key. [reCall] and [lib] are displayed in the weight and piece weight windows respectively.
2. Press the **C** key, [delete] is displayed in the weight window. Press the **Yes** key to delete the data.

4. MENU SETTINGS

The User Menu allows the customizing of scale settings.

Note: Additional Sub-Menus may be available if Interface Options are installed. See Interface User Manual for the additional setting information.

4.1 Menu Navigation

User Menu:

Menu:	<i>C.A.L</i>	<i>S.E.t.U.P</i>	<i>r.E.A.d</i>	<i>U.n.i.t</i>	⇒
Menu Items:	Zero ¹ Span1 Span2 ¹ Lin1 Lin2 ¹ GEO End	Reset D.Scale Cap2 ¹ Grad2 ¹ Pwr. Un Zero A.Opt A.Tare Bp.Opt Bp.Sig Bp.Key Accum End	Reset Stable Filter AZT Light A.Off End	Reset kg g lb oz lb:oz End	

⇒	<i>P.r.i.n.t.1</i>	<i>C.O.M.1</i>	<i>L.O.C.k</i>	<i>E.n.d</i>
Menu Items:	Reset Stable A.Print Contnt Layout Data.Tr End	Reset Baud Parity Stop Handsh Alt.Cm End	L.Cal L.Setup L.Read L.Unit L.Print L.COM End	

Notes:

¹ Only visible when dual scale is set to On.

Some units may not be available in all models.

When LEGAL FOR TRADE is set to ON (LFT Switch in locked position), the menu settings are affected as follows:

Calibration (*C.A.L*) menu is not accessible.

Dual Scale, Capacity 2, Graduation 2 and Units are locked at their current settings.

Zero Range setting is locked at 2%.

Stable Range setting is locked at 1d.

Auto-Zero Tracking setting is locked at 0.5d.

Stable Only is locked On.

Auto Print/ Continuous is disabled

Lb:oz is locked Off.

Summary of button navigation functions in menu mode:

- **Yes** Allows entry into the displayed menu.
 - Accepts the displayed setting and advances to the next item.
- **No** Skips by the displayed menu.
 - Rejects the displayed setting or menu item and advances to the next available item.
- **Back** Moves backwards through the upper and middle level menus.
 - Backs out of a list of selectable items to the previous middle level menu.
- **Exit** Exits from menu directly to the active weighing mode.

For menu items with numeric settings such as Capacity, the current setting is displayed with all digits flashing. Press the **No** button to begin editing. The first digit is displayed flashing.

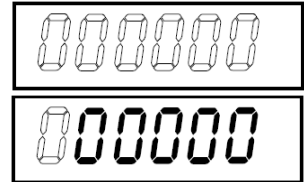

Press the **No** button to increment the digit or press the **Yes** button to accept the digit and move to the next digit.

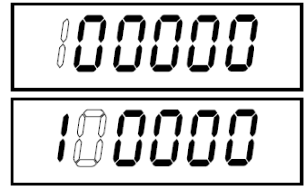

Repeat this process for all digits.

Press the **Yes** button when the last digit has been set.

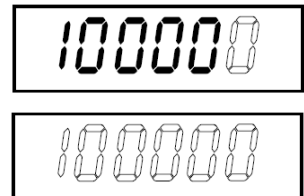

The new setting is displayed with all digits flashing. Press the **Yes** button to accept the setting or press the **No** button to resume editing.

This method also applies to setting Checkweigh under and over targets.

For End menu items, pressing the **Yes** button advances to the next menu, while pressing the **No** button returns to the top of the current menu.

4.2 Cal Menu

Enter this menu to perform calibrations.

Initial Calibration

When the scale is operated for the first time, a span calibration is recommended to ensure accurate weighing results. Before performing the calibration, be sure to have the appropriate calibration weights as listed in table 4-1. Ensure that the LFT switch/calibration lock is set to unlocked position. See figure 5-1.

Or adjust the GEO setting according to your location (see table 4-2).

Procedure:

Press and hold **Menu** until [mMeNU] (Menu) is displayed. When the button is released, the display will show [CAL]. Press **Yes** to accept. [spaN] will then be shown. Press **Yes** to begin the span calibration. [0kg] will be displayed. Press **Yes** to accept. [-C-] will be displayed while zero reading is stored. Next, the display shows the calibration weight value. Place the specified calibration mass on the pan. Press **Yes** to accept the weight or **No** to select an alternate weight. [-C-] will be displayed while the reading is stored. The display will show [done] if the calibration was successful. The scale returns to the previous application mode and is ready for use.

TABLE 4-1

Required Span Calibration Mass (sold separately)			
Capacity	Mass ¹	Capacity	Mass ¹
3000g	3kg / 6lb	15000g	15kg / 30lb
6000g	6kg / 15lb	30000g	30kg / 60lb

Note: ¹ Pound masses are used when calibrating in the lb unit.

Zero2:	Perform
Span1:	Perform
Span2:	Perform
Linearity1:	Perform
Linearity2:	Perform
Geographic	
Adjustment:	Set 0... 12 ...31*
End Calibration:	Exit menu

***Bold** always represents factory default value.

Zero2 [ZEro]

Initiates a 2nd scale zero calibration.

Span1 [SpaN]

Initiates a span calibration procedure (zero and span). A span calibration is important when initially setting up the scale.

Span2 [SpaN₂]

Initiates a 2nd scale span calibration procedure.

Lin1 [LIN]

Initiates a linearity calibration procedure (zero, mid-point and span).

Lin2 [LIN₂]

Initiates a 2nd scale linearity calibration procedure.

GEO [GEO]

Geographical Adjustment Factor (GEO) is used to adjust the calibration based on the current location. Settings from 0 to 31 are available with 12 being the default. Refer to table 4-2 to determine the GEO factor that corresponds to your location.

End Cal [End]

Advance to the next menu or return to the top of the current menu.

4.3 Setup Menu

Enter this menu to set scale parameters.

Reset:	no , yes
Dual Scale:	off , on
Cap2:	1 ...9999
Grad2:	0.00005...0.5
Power on unit:	auto , kg, g, lb, oz, lb:oz
Zero Range:	2%, 10%
Auto Opt:	off, on
Auto Tare:	on, off , on-acc
Beeper Opt:	off, on
Beeper Signal:	off , accept, under, over, under-over
Beeper Key:	off , on
Accumulation:	off , auto, manual
End Setup:	Exit menu

Reset [*reset*]

Reset the Setup menu to factory defaults.

NO = not reset
YES = reset

Dual Scale [*d.scale*]

Set the status of the second scale input (Scale 2).

OFF = disabled
ON = enabled

Cap2 [*CAP₂*]

Set the capacity of Scale 2.

1...9999

Grad2 [*GrAd₂*]

Set the readability of Scale 2.

0.00005...0.5

Power on unit [*pwWr.UN*]

Set the unit of measure displayed at startup.

AUTO = last unit in use when turned off
kg = kilograms
g = grams
lb = pounds
oz = ounces
lb:oz = pound ounces

Zero Range [*ZErO*]

Set the percentage of scale capacity that may be zeroed.

2% = zero up to 2 percent of capacity
10% = zero up to 10 percent of capacity

Auto Opt [*A.Opt*]

Set the Automatic Optimization.

OFF = disabled
ON = APW automatically optimized

Auto Tare [*A.tArE*]

Set the automatic tare functionality.

OFF = Automatic Tare is disabled
ON = the first stable gross weight is tared
ON-ACC = stable gross loads within the accept limits are tared (in Check weighing mode)

Beeper Opt [*bp.Opt*]

Set whether or not the beeper sounds when APW has been optimized.

OFF = disabled
ON = enabled

Beeper Signal [*Bp.slG*]

Set how the beeper responds in Check Weighing mode.

OFF = the beeper is disabled

ACCEPT = the beeper will sound when the weight is within the Accept range.

UNDER = the beeper will sound when the weight is below the Under setting.

OVER-

UNDER = the beeper will sound when the weight is above the Over setting.

OVER = the beeper will sound when the weight is below the Under setting or above the Over setting.

Beeper Key [BP.key]

Set whether the beeper sounds when a button is pressed.

OFF = no sound

ON = sound

Accumulation [aCCUmM]

Set the accumulation functionality.

OFF = accumulation disabled

AUTO = automatic accumulation

MAN = manual accumulation

End Setup [End]

Advance to the next menu or return to the top of the current menu.

4.4 Readout Menu

Enter this menu to set user preferences.

Reset:	no , yes
Stable Range:	0.5, 1 , 2, 5
Filter:	low, medium , high
Auto-Zero Tracking:	off, 0.5 , 1, 3
Light:	off, on, auto
Auto off:	off , 1, 5, 10
End Readout:	Exit menu

Reset [reset]

Reset the Read menu to factory defaults.

NO = not reset

YES = reset

Stable Range [Stable]

Set the amount the reading can vary while the stability symbol remains on.

0.5d = 0.5 scale division

1d = 1 scale division

2d = 2 scale division

5d = 5 scale division

Filter [FILtEr]

Set the amount of signal filtering.

LOW = less stability, faster stabilization time

MED = normal stability, stabilization time
 HI = greater stability, slower stabilization time

AZT [AZt]

Set the automatic zero tracking functionality.

OFF = disabled
 0.5d = the display will maintain zero until a change of 0.5 divisions per second has been exceeded.
 1d = the display will maintain zero until a change of 1 divisions per second has been exceeded.
 3d = the display will maintain zero until a change of 3 divisions per second has been exceeded.

Light [LIGHt]

Sets backlight functionality.

OFF = always off
 ON = always on
 AUTO = turns on when a button is pressed or the displayed weight changes.

Auto off [A.OFF]

Set the automatic shut off functionality.

OFF = disabled
 1 = powers off after 1 minute of no activity
 5 = powers off after 5 minute of no activity
 10 = powers off after 10 minute of no activity

End Readout [End]

Advance to the next menu or return to the top of the current menu.

4.5 Unit Menu

This sub-menu activates units so they will be accessible with the **Units** button. The units in the menu must be turned "on" to be active.

Note: Available units vary by model and local regulations.

4.6 Print1 Menu

Enter this menu to set printing parameters. Default settings are **bold**.

Note: The Print2 menu is only displayed if a second interface is installed.

Reset:	no , yes
Stable Only:	off , on
Auto Print:	off , on stable, interval, continuous, accept
Content:	P/N (-> off , on) Result (-> off, on) Gross (-> off , on) Net (-> off , on) Tare (-> off , on) Header (-> off , on) Footer (-> off , on) Mode (-> off , on) Unit (-> off, on) Info (-> off , on) APW (-> off , on) Acc (-> off , result, all)
Layout:	Format (-> S , M) Feed (-> Line , 4 Lines, form)

Reset [*reset*]

Reset the Print menu to factory defaults.

- NO = no reset
- YES = reset

Stable Only [*Stable*]

Set the printing criteria.

- OFF = values are printed immediately
- ON = values are only printed when the stability criteria are met

Auto Print [*A.Print*]

Set the automatic printing functionality.

- OFF = disabled
- ON.STAB = printing occurs each time the stability criteria are met
- INTER = printing occurs at the defined interval
- ACCEPT = printing occurs continuously
- CONT = printing occurs each time the display is within the Checkweigh accept range and stability criteria are met.

Content [*CONENT*]

Define the content of the printed data.

Part Number

Set the status.

- OFF = disabled
- ON = enabled

Result

Set the status.

- OFF = disabled
- ON = the displayed reading is printed

Gross

Set the status.

- OFF = disabled
- ON = the gross weight is printed

Net

Set the status.

- OFF = disabled
- ON = the net weight is printed

Tare

Set the status.

- OFF = disabled
- ON = the Tare weight is printed

Header

Set the status.

- OFF = disabled
- ON = the Header is printed

Note: See section 7.3.1 for how to enter Header line.

Footer

Set the status.

- OFF = disabled
- ON = the Footer is printed

Note: See section 7.3.1 for how to enter Footer line.

Mode

Set the status.

- OFF = disabled
- ON = the Mode is printed

Unit

Set the status.

- OFF = disabled
- ON = the Unit is printed

Info

Set the status.

- OFF = disabled
- ON = the reference information is printed

APW

Set the status.

- OFF = disabled
- ON = enabled

Accu

Set the status.

- OFF = disabled
- RESULT = the Accumulation result is printed
- ALL = all the Accumulation data is printed

Layout [*layOut*]

Set the format of the data output to a printer or computer.

Format

Set the printing format.

- MULTI = a multi-line (single column style) printout is generated.
- SINGLE = a single line printout is generated.

Feed

Set the paper feed.

- LINE = move a paper up one line after printing
- 4LF = move a paper up four lines after printing
- FORM = a form feed is appended to the printout

Data Transfer [*data.tr*]

Output weighing results directly to a PC application.

- OFF = disabled
- ON = enabled

Windows XP Setup:

1. Click Start Menu in Windows XP and click Settings -> open **Control Panel**.
2. Double click **Accessibility Options** in Control Panel.
3. Select the **General** tab.

4. Check **Use Serial Keys**, and click the **Settings** button.
5. Select the **Serial Port**, set the Baud rate to **9600** and click **OK**.
6. Close the Control Panel.
7. Run Excel to open one blank sheet. Focus the cursor on one item. At this time, if scale sends data to the PC through the RS232 port, the data will be put into the cell, and the cursor will automatically move to the next vertical cell.

Notes:

For Windows 7 setup, contact Ohaus.

If the weighing value is a negative number, set the target cell in TEXT format. Otherwise, Excel will not distinguish it as a negative number.

Please do not use this function during continuous printing.

Print Library [P.lib]

Print the library data.

No = disabled

Yes = All library records stored in memory are printed

End Print [End]

Advance to the next menu or return to the top of the current menu.

4.7 COM1 Menu

Enter this menu to define communication parameters

Reset:	no, yes
Baud Rate:	300... 9600 ...19200
Parity:	7 even, 7 odd, 7 none, 8 none
Stop bit:	1, 2
Handshake:	none , On-Off
Alternate command:	Print (A... P ...Z), Tare (A... T ...Z), Zero (A... Z)
End COM:	Exit menu

Note: The COM2 menu is only displayed if a second interface is installed.

Reset [reset]

Reset the COM menu to factory defaults.

NO = no reset

YES = reset

Baud Rate [BAUD]

Set the baud rate.

300 = 300 bps

600 = 600 bps

1200 = 1200 bps

2400 = 2400 bps

4800 = 4800 bps

9600 = 9600 bps

19200 = 19200 bps

Parity [paritY]

Set the data bits and parity.

7 EVEN = 7 data bits, even parity

- 7 ODD = 7 data bits, odd parity
- 7 NONE = 7 data bits, no parity
- 8 NONE = 8 data bits, no parity

Stop bit [*stOP*]

Set the number of stop bits.

- 1 = 1 stop bits
- 2 = 2 stop bits

Handshake [*H.shake*]

Set the flow control method. Hardware handshaking is only available for COM1 menu.

- NONE = no handshaking
- ON-OFF = XON/XOFF software handshaking

Alternate command [*Alt.CmM*]

Define command character for the Print, Tare and Zero commands

Print

Set the alternate command character for Print
A to Z.

Tare

Set the alternate command character for Tare
A to Z.

Zero

Set the alternate command character for Zero.
A to Z.

End COM1, End COM2 [*End*]

Advance to the next menu or return to the top of the current menu.

4.8 Lock Menu

The Lock Menu is a software controlled option which can lock Menu settings to prevent tampering.

Reset	no , yes
Lock Cal	off , on
Lock Setup	off , on
Lock Read	off , on
Lock Unit	off , on
Lock Print	off , on
Lock COM	off , on
End Menu Lock	Exit menu

Reset [*reset*]

Reset the Lock menu to factory defaults.

- NO = no reset
- YES = reset

Lock Cal [*L.CAL*]

Set the status.

- OFF = Calibration menu is not locked
- ON = Calibration menu is locked

Lock Setup

Set the status.

- OFF = Setup menu is not locked
- ON = Setup menu is locked

Lock Read

Set the status.

- OFF = Readout menu is not locked
- ON = Readout menu is locked

Lock Unit [L.Unit]

Set the status.

- OFF = Unit menu is not locked
- ON = Unit menu is locked

Lock Print

Set the status.

- OFF = Print menu is not locked
- ON = Print menu is locked

Lock COM [L.COMM]

Set the status.

- OFF = COM menu is not locked
- ON = COM menu is locked

End Lock [End] – Advance to the next menu or return to the top of the current menu.

4.9 End Menu

Press 'Yes' to advance to the Calibration menu. Press 'No' to exit the menu and return to the current application mode.

4.10 Additional Features

To use this feature, remove AC power from the scale and remove the protective cover for the weigh below opening. Install a suitable hook into the access hole at the bottom of the scale as shown. Do not over tighten, tighten finger tight. Mount the scale onto an appropriate assembly that allows free working space below the hook. See figure 4-1. Refer to section 6.4 for optional hook.

Note: Never allow the scale to rest directly on the hook.

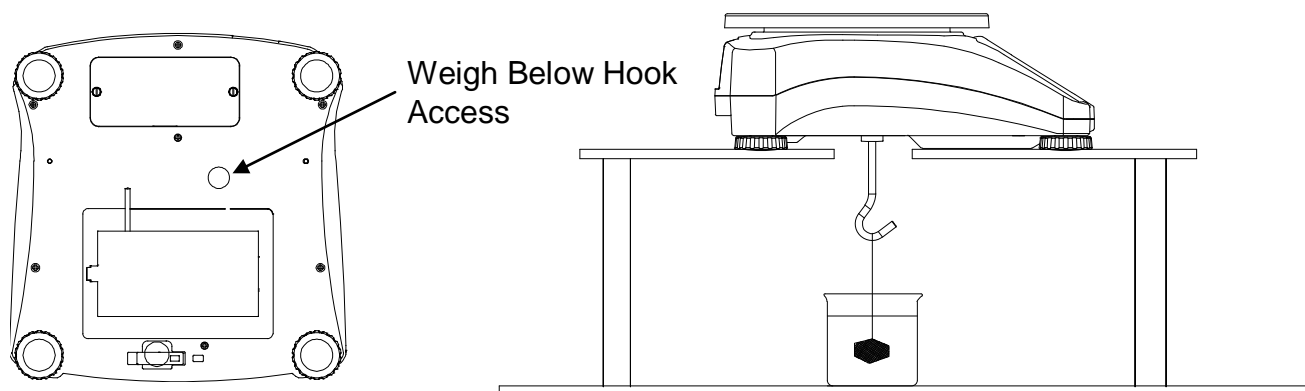

Figure 4-1. Setup for the Weigh Below Hook

TABLE 4-2. GEO CODES

Latitude		Elevation in meters										
		0	325	650	975	1300	1625	1950	2275	2600	2925	3250
		325	650	975	1300	1625	1950	2275	2600	2925	3250	3575
		Elevation in feet										
		0	1060	2130	3200	4260	5330	6400	7460	8530	9600	10660
		1060	2130	3200	4260	5330	6400	7460	8530	9600	10660	11730
		GEO value										
0°00'	5°46'	5	4	4	3	3	2	2	1	1	0	0
5°46'	9°52'	5	5	4	4	3	3	2	2	1	1	0
9°52'	12°44'	6	5	5	4	4	3	3	2	2	1	1
12°44'	15°06'	6	6	5	5	4	4	3	3	2	2	1
15°06'	17°10'	7	6	6	5	5	4	4	3	3	2	2
17°10'	19°02'	7	7	6	6	5	5	4	4	3	3	2
19°02'	20°45'	8	7	7	6	6	5	5	4	4	3	3
20°45'	22°22'	8	8	7	7	6	6	5	5	4	4	3
22°22'	23°54'	9	8	8	7	7	6	6	5	5	4	4
23°54'	25°21'	9	9	8	8	7	7	6	6	5	5	4
25°21'	26°45'	10	9	9	8	8	7	7	6	6	5	5
26°45'	28°06'	10	10	9	9	8	8	7	7	6	6	5
28°06'	29°25'	11	10	10	9	9	8	8	7	7	6	6
29°25'	30°41'	11	11	10	10	9	9	8	8	7	7	6
30°41'	31°56'	12	11	11	10	10	9	9	8	8	7	7
31°56'	33°09'	12	12	11	11	10	10	9	9	8	8	7
33°09'	34°21'	13	12	12	11	11	10	10	9	9	8	8
34°21'	35°31'	13	13	12	12	11	11	10	10	9	9	8
35°31'	36°41'	14	13	13	12	12	11	11	10	10	9	9
36°41'	37°50'	14	14	13	13	12	12	11	11	10	10	9
37°50'	38°58'	15	14	14	13	13	12	12	11	11	10	10
38°58'	40°05'	15	15	14	14	13	13	12	12	11	11	10
40°05'	41°12'	16	15	15	14	14	13	13	12	12	11	11
41°12'	42°19'	16	16	15	15	14	14	13	13	12	12	11
42°19'	43°26'	17	16	16	15	15	14	14	13	13	12	12
43°26'	44°32'	17	17	16	16	15	15	14	14	13	13	12
44°32'	45°38'	18	17	17	16	16	15	15	14	14	13	13
45°38'	46°45'	18	18	17	17	16	16	15	15	14	14	13
46°45'	47°51'	19	18	18	17	17	16	16	15	15	14	14
47°51'	48°58'	19	19	18	18	17	17	16	16	15	15	14
48°58'	50°06'	20	19	19	18	18	17	17	16	16	15	15
50°06'	51°13'	20	20	19	19	18	18	17	17	16	16	15
51°13'	52°22'	21	20	20	19	19	18	18	17	17	16	16
52°22'	53°31'	21	21	20	20	19	19	18	18	17	17	16
53°31'	54°41'	22	21	21	20	20	19	19	18	18	17	17
54°41'	55°52'	22	22	21	21	20	20	19	19	18	18	17
55°52'	57°04'	23	22	22	21	21	20	20	19	19	18	18
57°04'	58°17'	23	23	22	22	21	21	20	20	19	19	18
58°17'	59°32'	24	23	23	22	22	21	21	20	20	19	19
59°32'	60°49'	24	24	23	23	22	22	21	21	20	20	19
60°49'	62°00'	25	24	24	23	23	22	22	21	21	20	20
62°00'	63°30'	25	25	24	24	23	23	22	22	21	21	20
63°30'	64°55'	26	25	25	24	24	23	23	22	22	21	21
64°55'	66°24'	26	26	25	25	24	24	23	23	22	22	21
66°24'	67°57'	27	26	26	25	25	24	24	23	23	22	22
67°57'	69°35'	27	27	26	26	25	25	24	24	23	23	22
69°35'	71°21'	28	27	27	26	26	25	25	24	24	23	23
71°21'	73°16'	28	28	27	27	26	26	25	25	24	24	23
73°16'	75°24'	29	28	28	27	27	26	26	25	25	24	24
75°24'	77°52'	29	29	28	28	27	27	26	26	25	25	24
77°52'	80°56'	30	29	29	28	28	27	27	26	26	25	25
80°56'	85°45'	30	30	29	29	28	28	27	27	26	26	25
85°45'	90°00'	31	30	30	29	29	28	28	27	27	26	26

5. LEGAL FOR TRADE

When the scale is used in trade or a legally controlled application it must be set up, verified and sealed in accordance with local weights and measures regulations. It is the responsibility of the purchaser to ensure that all pertinent legal requirements are met.

5.1 Capacity Label

A label showing the capacity and readability of the scale must be installed near each display. If the Capacity Labels were installed prior to delivery, no further action is needed. If the Capacity Labels were not installed, they have been placed in the packaging material. Affix the labels above the displays as shown in Figure 5-1.

Note: The Capacity Labels will be destroyed upon removal, so only attempt to install them once.

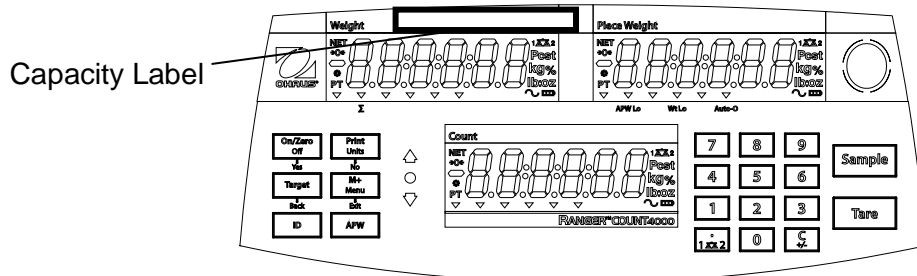

Figure 5-1. Capacity Label location

5.2 Settings

Before verification and sealing, perform the following steps:

1. Verify that the menu settings meet the local weights and measures regulations.
2. Perform a calibration as explained in Section 3.9.
3. Set the switch to Locked. See figure 5-1.

The Menu Lock switch limits changes to the Cal, Setup, Readout, Unit and Print menus. The switch in type approved models may set some scale settings as required by the approval agency. The switch may be secured using paper seals, wire seals or plastic ties.

Note: When LEGAL FOR TRADE is set to ON (LFT Switch in locked position), the menu settings are affected as follows:

- Calibration (CAL) menu is not accessible
- Dual Scale, Capacity 2, Graduation 2 and Units are locked at their current settings
- Zero Range setting is locked at 2%
- Stable Range setting is locked at 1d
- Auto-Zero Tracking setting is locked at 0.5d
- Stable Only is locked On
- Auto Print/ Continuous is disabled
- Lb:oz is locked Off

5.2 Verification and Sealing

The local weights and measures official or authorized service agent must perform the verification procedure.

5.3.1 Physical Seals

For jurisdictions that use the physical sealing method, the local weights and measures official or authorized service agent must apply a security seal to prevent tampering with the settings. Refer to the illustration below for sealing methods.

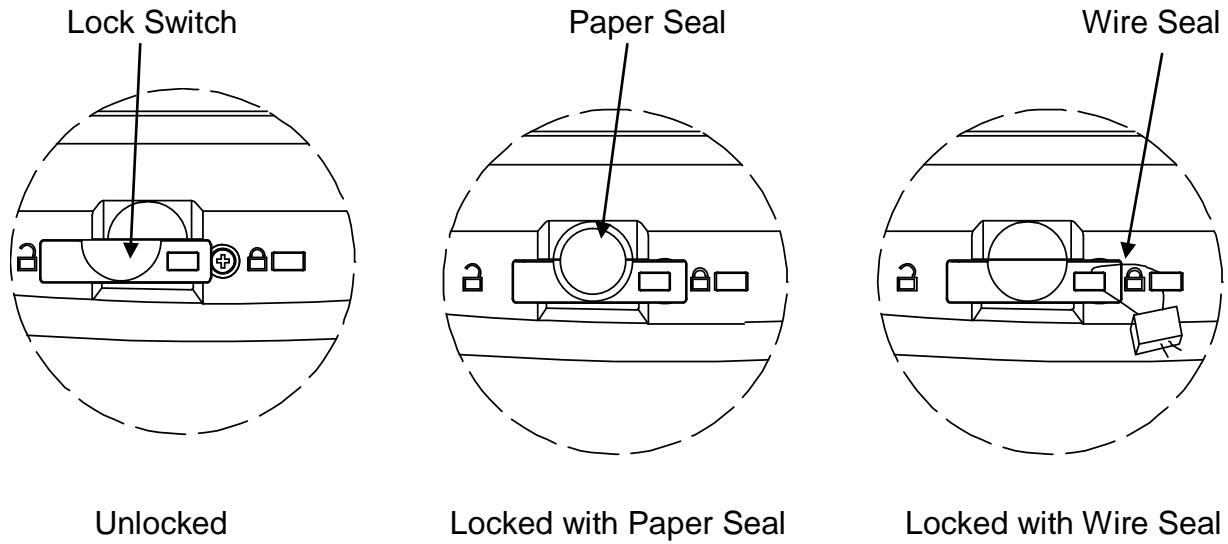

Figure 5-1. Sealing

6. MAINTENANCE

6.1 Cleaning



WARNING: Electric Shock Hazard. Disconnect the scale from the power supply before cleaning. Make sure that no liquid enters the interior of the scale during cleaning.

The housing may be cleaned with a cloth dampened with a mild detergent if necessary.

Attention: Do not use solvents, chemicals, alcohol, ammonia or abrasives to clean the housing or control panel.

6.2 Troubleshooting

Table 6-1 lists common problems and possible causes and remedies.

If the problem persists, contact OHAUS or your authorized dealer.

TABLE 6-1

Symptom	Possible Cause	Remedy
Cannot turn on	No power to scale	Verify connections and voltage
Poor accuracy	Improper calibration Unstable environment	Perform calibration Move scale to suitable location
Cannot calibrate	Unstable environment Incorrect calibration weight	Move the scale to suitable location Use correct calibration weight
Cannot access mode	Mode not enabled	Enter menu and enable mode
Cannot access unit	Unit not enabled	Enter menu and enable unit
Battery icon flashing	Battery is empty	Connect the scale to AC power and charge the battery
Err 8.1	Power On Error	Weight reading exceeds Power On Zero limit
Err 8.2	Power On Error	Weight reading below Power On Zero limit
Err 8.3	Over Range Error	Weight reading exceeds Overload limit
Err 8.4	Under Range Error	Weight reading below Underload limit
Err 8.5	Tare out of range	Adjust tare value to be within range
Err 8.6	Display overflow	Weight exceeds 6 digits
Err 9.5	Calibration data error	Calibration data not present
—	Busy	Displayed during tare setting, zero setting, printing
–NO–	Action not allowed	Function not executed
CAL E	Calibration error Unstable environment Incorrect calibration weight	Calibration value outside allowed limits Move the scale to suitable location Use correct calibration weight
Lo.REF	Low reference weight warning	Increase reference weight.
rEF.Err	Unacceptable reference weight	Reference weight too small. Weight on the pan is too small to define a valid reference weight. Increase reference weight.
Battery fails to charge fully	Battery is defective	Have battery replaced by Ohaus authorized service dealer.

6.3 Service Information

If the troubleshooting section does not resolve or describe your problem, contact your authorized OHAUS service agent. For service assistance or technical support in the United States call toll-free 1-800-526-0659 between 8:00 AM and 5:00 PM EST. An OHAUS product service specialist will be available to provide assistance. Outside the USA, please visit our web site, www.ohaus.com to locate the OHAUS office nearest you.

6.4 Accessories

2 nd scale Interface Kit	30037446
Ethernet Interface Kit	30037447
2 nd RS232 Interface Kit	30037448
USB Interface Kit	30037449
In Use Cover	30240697
Weigh Below Hook	30037450
Printer	Contact Ohaus
Communication Cables	Contact Ohaus

7. TECHNICAL DATA

The technical data is valid under the following ambient conditions:

Indoor use only

Operating temperature: -10°C to 40°C

Relative humidity: maximum relative humidity 80 % for temperatures up to 31 °C
decreasing linearly to 50 % relative humidity at 40 °C

Altitude: Up to 2000 m

Power: AC power 100-240V 50/60 Hz, internal rechargeable sealed lead-acid battery

Mains supply voltage fluctuations: up to ± 10% of the nominal voltage

Pollution degree: 2

Installation category: II

7.1 Specifications

TABLE 7-1

MODEL	RC41M3	RC41M6	RC41M15	RC41M30
Capacity x Readability (Max x d non-approved)	3 kg x 0.0001 kg 3000 g x 0.1 g 6 lb x 0.0002 lb 96 oz x 0.003 oz	6 kg x 0.0002 kg 6000 g x 0.2 g 15 lb x 0.0004 lb 240 oz x 0.006 oz	15 kg x 0.0005 kg 15000 g x 0.5 g 30 lb x 0.001 lb 480 oz x 0.02 oz	30 kg x 0.001 kg 30000 g x 1 g 60 lb x 0.002 lb 960 oz x 0.04 oz
Maximum Displayed Resolution	1:30000			
Minimum Recommended Sample Weight	2g / 0.004lb	4g / 0.01lb	10g / 0.02lb	20g / 0.04lb
Minimum Recommended APW	0.01g / 0.00002lb	0.02g / 0.00005lb	0.05g / 0.0001lb	0.1 g / 0.0002lb
Capacity x Readability (Max x e approved)	3 kg x 0.001 kg 3000 g x 1 g 6 lb x 0.002 lb 96 oz x 0.03 oz	6 kg x 0.002 kg 6000 g x 2 g 15 lb x 0.004 lb 240 oz x 0.06 oz	15 kg x 0.005 kg 15000 g x 5 g 30 lb x 0.01 lb 480 oz x 0.2 oz	30 kg x 0.01 kg 30000 g x 10 g 60 lb x 0.02 lb 960 oz x 0.4 oz
Approved Resolution	1:3000			
Repeatability	±0.0002 kg	±0.0005 kg	±0.001 kg	±0.002 kg
Linearity	±0.0002 kg	±0.0005 kg	±0.001 kg	±0.002 kg
Weighing Units	Non-Approved models: g, kg, lb, oz, lb:oz EC and OIML Approved models: g, kg Measurement Canada and NTEP Approved models: g, kg, lb, oz			
Tare Range	To capacity by subtraction			
Stabilization Time	1 second			
Weight Display	3 LCD with white LED backlight 6-digit 7-segment, 20.5 mm / 0.8 in in characters			
Keyboard	20 mechanical buttons			
Battery Operating Time (at 20°C)	210 hours with backlight turned off			
Construction	ABS plastic housing with 304 stainless steel (SST) platform			
Approval Class	III			
Pan Dimensions	225 x 300 mm			
Net Weight	5.9 kg / 13 lb			
Gross Weight	7.2 kg / 15.9 lb			

7.2 Drawings

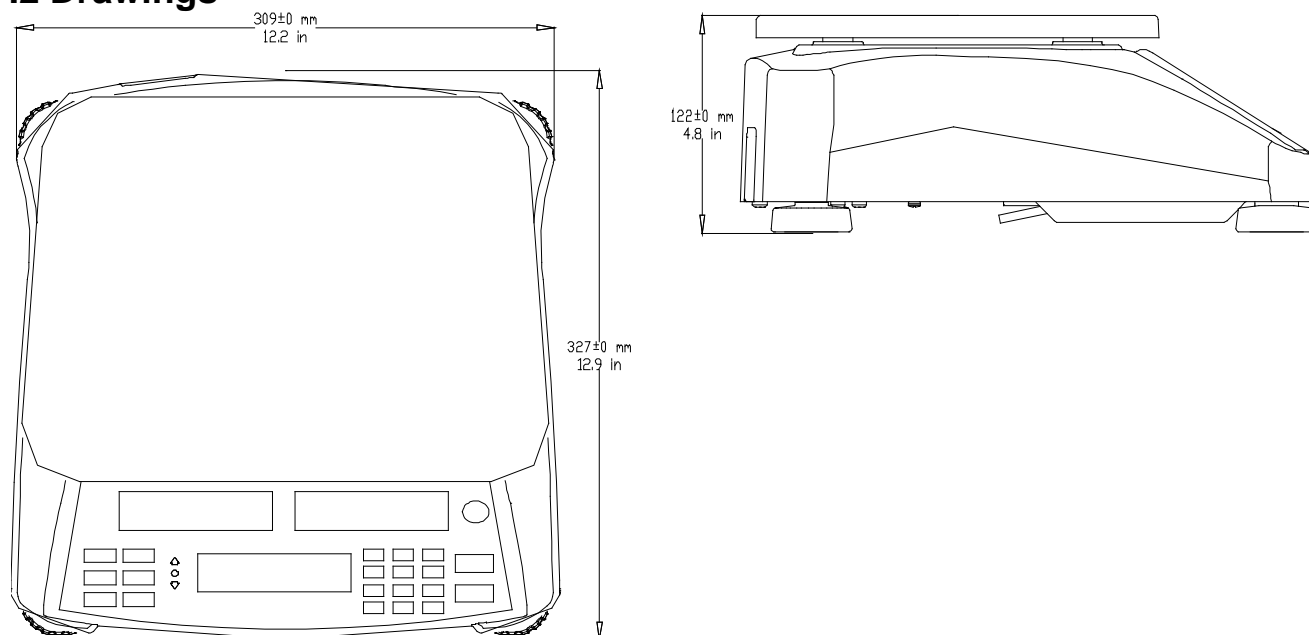

7.3 Communication

The scale is equipped with an RS232 interface (COM1) located under the Options Cover. Connecting the scale to a computer enables you to operate the scale from the computer, as well as receive data such as displayed weight.

7.3.1 Interface Commands

The scale supports both MT-SICS and OHAUS commands. Commands listed in the following tables will be acknowledged by the scale. To use the MT-SICS commands, send the command PSI. To return to the OHAUS commands, send the command POH

TABLE 7-2

Command	Function
IP	Immediate Print of displayed weight (stable or unstable).
P	Print displayed weight (stable or unstable).
CP	Continuous Print.
SP	Print on Stability.
xS	0S: Turn off "Stable Only" menu item and allow unstable print. 1S: Turn on "Stable Only" menu item and only print stable print.
xP	Interval Print x = Print Interval (1-3600 sec), 0P turns auto print OFF
Z	Same as pressing Zero Key.
T	Same as pressing Tare Key.
xT	Download Tare value in grams (positive values only). Sending 0T clears tare (if allowed).
PU	Print current unit: g, kg, lb, oz, lb:oz, t, c (custom)
xU	Set scale to unit x: 1=g, 2=kg, 3=lb, 4=oz, 5=lb:oz, 6=t
xM	Set scale to mode x. M will scroll to next enabled mode.
PV	Version: print name, software revision and LFT ON (if LFT is set ON).
H x "text"	Enter Header line, where x = line number 1 to 5, "text" = header text up to 24 alphanumeric characters
F x "text"	Enter Footer line, where x = line number 1 to 2, "text" = rear text up to 24 alphanumeric characters
\EscR	Global reset to reset all menu settings to the original factory defaults (Escape key + 'R' Key)

MT-SICS Commands

	Command	Function
LEVEL 0	@	Reset the scale
	I0	Inquiry of all available SICS commands
	I1	Inquiry of SICS level and SICS versions
	I2	Inquiry of scale data
	I3	Inquiry of scale software version
	I4	Inquiry of serial number
	S	Send stable weight value
	SI	Send weight value immediately
	SIR	Send weight value repeatedly
	Z	Zero the scale
	ZI	Zero immediately
LEVEL 1	D	Write text into display
	DW	Weight display
	SR	Send and repeat stable weight value
	T	Tare
	TA	Tare value
	TAC	Clear tare
	TI	Tare immediately

7.3.2 Connections for RS232

The 9-pin female subminiature “D” connector COM1, is provided for interfacing to other devices. The pin connections are as follows:

Active pins: PIN 2 = TXD, PIN 3 = RXD, PIN 5 = Ground

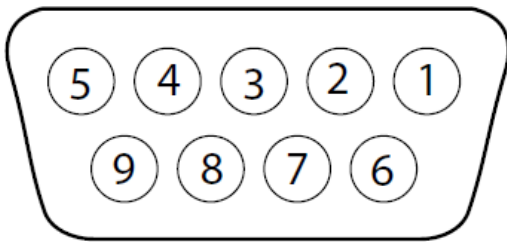

Figure 7-2. RS232 Pins

7.4 Printouts

The following sample print outs are generated by the **Print** button, “P” Command or alternate print command. The content of the printout is defined in the Print Content menu item. A maximum of 24 characters can be printed on each line.

	Description	Comment
PN: 123456789926	Part Number line	If Printx → Content → P/N is ON
926 PCS	Result line	If Printx → Content → Result is ON
12.33 kg G	Gross value line	If Printx → Content → Gross is ON and a tare value is entered
11.11 kg NET	Net value line	If Printx → Content → Net is ON and a tare value is entered
1.22 kg T	Tare value line	If Printx → Content → Tare is ON and a tare value is entered
APW: 1.2 g	Information line	If Printx → Content → Info is ON
N: 3	Accumulation line	If Printx → Content → Accu is All
ACC: 2875 Pcs	Accumulation line	If Printx → Content → Accu is All

7.5 Output Format

Weight string print format:

Field	Weight	space	Unit	space	Stability	space	G/N	Space	Term. Char(s)
Length	9	1	5	1	1	1	NET	1	

Each field is followed by a single delimiting space (ASCII: 32)

Definitions:

Weight - Up to 9 characters, right justified, - at immediate left of most significant character (if negative).

Unit - Up to 5 characters, left justified. If the Unit in the Print Content menu was set to OFF, the unit will be removed in the weight string and replaced by spaces.



Stability - “?” character is printed if not stable. If weight is stable neither “?” or following space is printed.

G/N - “NET” printed if weight is net weight, ‘G’ or nothing printed if weight is a gross weight.



Terminating Character(s) - terminating character(s) printed depending on FEED menu setting.



7.6 Compliance

Compliance to the following standards is indicated by the corresponding mark on the product.

Mark	Standard
	This product conforms to the EMC Directive 2004/108/EC, the Low Voltage Directive 2006/95/EC and the Non-Automatic Weighing Instrument Directive 2009/23/EC. The Declaration of Conformity is available online at www.ohaus.com/ce .
	AS/NZS 61000.6.1, AS/NZS 61000.6.3
	UL Std. No. 61010-1 CAN/CSA-C22.2 No. 61010-1

Important notice for verified weighing instruments

  Weighing Instruments verified at the place of manufacture bear one of the preceding marks on the packing label and the green 'M' (metrology) sticker on the descriptive data plate. They may be put into service immediately.

  Weighing Instruments to be verified in two stages have no green 'M' (metrology) on the descriptive data plate and bear one of the preceding identification marks on the packing label. The second stage of the initial verification must be carried out by an authorized and certified service organization established within the European Community or by the National Notified Body.

The first stage of the initial verification has been carried out at the manufacturers work. It comprises all tests according to the adopted European standard EN 45501:1992, paragraph 8.2.2.

If national regulations limit the validity period of the verification, the user of the weighing instrument must strictly observe the re-verification period and inform the respective weights and measures authorities.

FCC Note

This equipment has been tested and found to comply with the limits for a Class B digital device, pursuant to Part 15 of the FCC Rules. These limits are designed to provide reasonable protection against harmful interference in a residential installation. This equipment generates, uses and can radiate radio frequency energy and, if not installed and used in accordance with the instructions, may cause harmful interference to radio communications. However, there is no guarantee that interference will not occur in a particular installation. If this equipment does cause harmful interference to radio or television reception, which can be determined by turning the equipment off and on, the user is encouraged to try to correct the interference by one or more of the following measures:

- Reorient or relocate the receiving antenna.
- Increase the separation between the equipment and receiver.
- Connect the equipment into an outlet on a circuit different from that to which the receiver is connected.
- Consult the dealer or an experienced radio/TV technician for help.

Industry Canada Note

This Class B digital apparatus complies with Canadian ICES-003.

ISO 9001 Registration

In 1994, OHAUS Corporation, USA, was awarded a certificate of registration to ISO 9001 by Bureau Veritas Quality International (BVQI), confirming that the OHAUS quality management system is compliant with the ISO 9001 standard's requirements. On June 21, 2012, OHAUS Corporation, USA, was re-registered to the ISO 9001:2008 standard.

Disposal

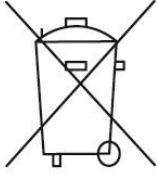

In conformance with the European Directive 2002/96/EC on Waste Electrical and Electronic Equipment (WEEE) this device may not be disposed of in domestic waste. This also applies to countries outside the EU, per their specific requirements.

The Batteries Directive 2006/66/EC introduces new requirements from September 2008 on removability of batteries from waste equipment in EU

Member States. To comply with this Directive, this device has been designed for safe removal of the batteries at end-of-life by a waste treatment facility.

Please dispose of this product in accordance with local regulations at the collecting point specified for electrical and electronic equipment. If you have any questions, please contact the responsible authority or the distributor from which you purchased this device.

Should this device be passed on to other parties (for private or professional use), the content of this regulation must also be related.

Disposal instructions in Europe are available online at www.ohaus.com/weee.

Thank you for your contribution to environmental protection.

Limited Warranty

OHAUS products are warranted against defects in materials and workmanship from the date of delivery through the duration of the warranty period. During the warranty period OHAUS will repair, or, at its option, replace any component(s) that proves to be defective at no charge, provided that the product is returned, freight prepaid, to OHAUS. This warranty does not apply if the product has been damaged by accident or misuse, exposed to radioactive or corrosive materials, has foreign material penetrating to the inside of the product, or as a result of service or modification by other than OHAUS. In lieu of a properly returned warranty registration card, the warranty period shall begin on the date of shipment to the authorized dealer. No other express or implied warranty is given by OHAUS Corporation. OHAUS Corporation shall not be liable for any consequential damages.

As warranty legislation differs from state to state and country to country, please contact OHAUS or your local OHAUS dealer for further details.